

A-7V Video Phone User Manual



Version 5.42.1.0.X
May. 2022

Notices Information

Copyright

Copyright © 2022 Zoeylink Innovation (Shenzhen) Co., Ltd. All rights reserved.

Zoeylink owns all the rights to modify and copy this document at any time. And all the illustrations and text in this document are copyright protected. Therefore, no parts of this document may be used or reproduced, transmitted by the third parties for any purposes without the express written permission of Zoeylink.

When this document is made available on www.zoeylink.com, Zoeylink gives its right to download and print copies of this content only for private use as a user manual. No parts shall have the right to alter, modify or use as commercial means without prior written permission from Zoeylink.

Safety Instructions

- To use the Phone, please follow the instructions in this user manual.
- Use the power adapter supplied with your phone. Other power adapters may damage the phone.
- This phone is only for indoor use. And also avoid in high humidity, water and some other liquids.
- Do not use the phone during thunderstorms.
- CE
- FCC

WEEE Warning



To avoid the potential effects on the environment and human health as a result of the presence of hazardous substances in electrical and electronic equipment, end users of electrical and electronic equipment should understand the meaning of the crossed-out wheeled bin symbol. Do not dispose of WEEE as unsorted municipal waste and have to collect such WEEE separately.

Cleaning

To clean the device, use an anti-static cloth. Please avoid cleaning liquids as they might damage the surface or internal electronics of the phone.

FCC Statement

This device complies with Part 15 of the FCC Rules. Operation is subject to the following two conditions: (1) This device may not cause harmful interference, and (2) this device must accept any interference received, including interference that may cause undesired operation.

WARNING: Any changes or modifications not expressly approved by the party responsible for compliance could void the user's authority to operate this equipment.

NOTE: This equipment has been tested and found to comply with the limits for a Class B digital device, pursuant to Part 15 of the FCC Rules. These limits are designed to provide reasonable protection against harmful interference in a residential installation.

This equipment generates uses and can radiate radio frequency energy and, if not installed and used in accordance with the instructions, may cause harmful interference to radio communications.

However, there is no guarantee that interference will not occur in a particular installation. If this equipment does cause harmful interference to radio or television reception, which can be determined by turning the equipment off and on, the user is encouraged to try to correct the interference by one or more of the following measures:

- Reorient or relocate the receiving antenna.
- Increase the separation between the equipment and receiver.
- Connect the equipment into an outlet on a circuit different from that to which the receiver is connected.
- Consult the dealer or an experienced radio/TV technician for help.

*RF warning for Mobile device:

This equipment complies with FCC radiation exposure limits set forth for an uncontrolled environment. This equipment should be installed and operated with minimum distance 20cm between the radiator & your body.

Table of Content

Notices Information.....	2
Copyright	2
Safety Instructions	2
WEEE Warning.....	2
Cleaning.....	3
FCC Statement	3
Table of Content.....	4
Before You Begin	8
Getting Started.....	9
Packing List	9
Phone Installation	11
Hardware Components Preview.....	12
Idle Screen.....	13
Initialization Process.....	14
Status.....	14
Registration.....	14
Getting Familiar with Your Phone	17
Icon Preview	17
LED and Icon Instruction	19
Power Indicator LED	19
Line Icon (Line Key set as Line).....	19
BLF or BLF List Key Icon (Line/Line Key set as BLF)	19
Shared Line Icon	20
User Interface	20
Call Features.....	21
Basic Call Features	21
Place a Call	21
Place a Video Call	23
End a Call.....	23
Redial a Call	23
Receive a Call	24
Incoming Call Show Mode	24
Auto Answer	24
Call Hold/Resume	25
Call Transfer	25
Call Conference.....	28
Call Forward	28
Call Return	30
Call Waiting Tone.....	31
Call Mute	31
DND.....	32

Hot Line	32
Auto Redial	33
Advanced Call Features	33
Call Pickup	33
Group Pickup.....	34
Call Park	35
Busy Lamp Field (BLF)	36
Visual Alert for BLF Pickup.....	36
Audio Alert for BLF Pickup	37
BLF List	38
Shared Line	39
Intercom.....	40
Intercom Barge.....	41
Voice Mail	41
Using the Hot Desking	43
Contacts	44
Local Contacts	44
Contact Groups	44
Managing the Local Contacts.....	45
Moving a Local Contact to Blacklist	48
Searching for Contacts.....	48
To import or export the contact list	49
Blacklist.....	50
Adding a Blacklist Contact	50
Viewing Blacklist Contacts	50
Deleting Blacklist Contacts.....	50
Moving a Blacklist Contact to the Local Contacts.....	51
Remote Phonebook.....	52
LDAP Phonebook	53
Recent Calls Setting	55
Recent Calls	55
Audio Settings.....	58
Ring Tone.....	58
Volume.....	60
Voice Mail Tone.....	60
Play Hold Tone.....	60
Play Hold Tone Delay	60
Voice	61
Handfree AGC	61
Volume Amplification	62
Handset Send Volume	62
Headset Send Volume	62
Handfree Send Volume	63
Extra Loud	63

Bluetooth.....	64
How to Activate Bluetooth?	64
To activate Bluetooth via Phone interface:.....	64
How to scan the Bluetooth headset device on phone interface:	65
How to edit device information?	65
How to edit device information on phone interface:.....	65
How to answer an incoming call?.....	65
How to adjust the earphone volume during a call?	66
How to End Call?	66
Wi-Fi.....	66
How to Enable Wi-Fi feature?	66
How to Connect Smart Phone to an Available Wireless Network?	66
How to Disconnect Wireless Network?	67
How to Disable Wi-Fi feature?	67
Function Key	67
Line Keys	67
Line.....	67
Speed Dial	68
BLF	69
DTMF.....	69
Prefix	70
Local Group.....	71
XML Group	71
XML Browser	72
Network Directories.....	73
Conference	74
Forward	74
Transfer	75
Hold	76
DND.....	76
Redial	77
Record.....	78
Group Listening.....	78
Public Hold	79
Private Hold.....	79
Multicast Paging	80
Customizing Your Phone	84
Administrator Password.....	84
Language.....	85
Wallpaper.....	85
Screen Saver	86
Backlight	86
Time and Date	87
LED Status Setting	90

Key as Send	90
Dial Plan	91
Phone Lock.....	93
Emergency Call	94
Action URL.....	95
Settings	96
General Settings.....	96
Dial-Now Timeout	96
No Key Entry Timeout	97
Show Missed Calls	97
Auto Logout Time	98
Reboot in Talking.....	98
Redial Mode	98
Suppress DTMF Display	99
Headset Mode	99
Network setting.....	100
IPv4	100
PC Port.....	102
System setting	102
Factory Reset	102
Pcap Feature.....	103
System Log	103
Upgrade.....	104
Configuration File	105
Optional Accessories with Your Phone	107
Headsets.....	107
Bluetooth Headset.....	107
Using Headsets	107

Before You Begin

This guide provides information you need to quickly use your new phone.

Firstly, verify with your system administrator that the IP network is ready for phone configuration. Also, be sure to read the Quick Start Guide which can be found in your phone package before you set up and use the phone. As you read this guide, keep in mind that some features are only configurable by your system administrator or determined by your phone environment. As a result, some features may not be enabled or may be operated differently on your phone. Additionally, the examples and graphics in this guide may not directly reflect what is displayed or is available on your phone screen.

Getting Started

Packing List

The package contains the following parts, please check if all the items are not missed:

1. The phone station

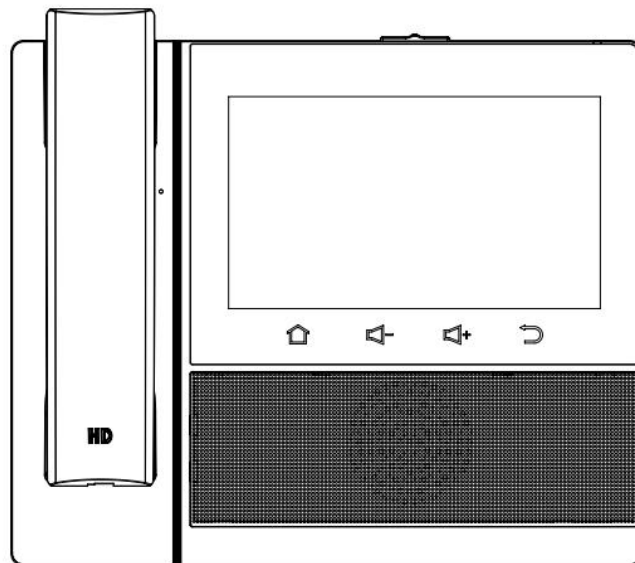

2. Handset

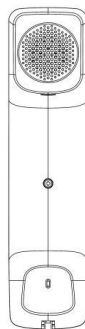

3. Headset cord

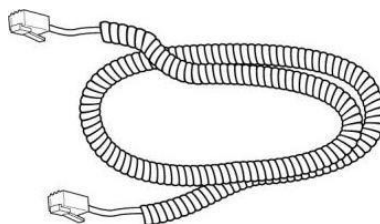

4. Power adapter

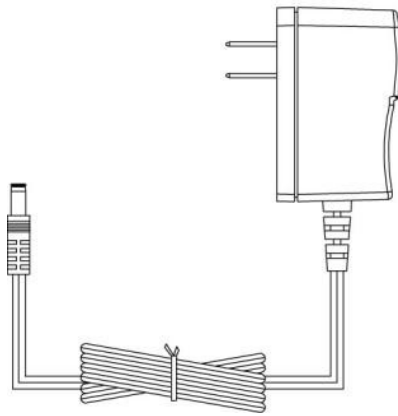

Phone Installation

1. Attach the phone stand
2. Connect the Handset and optional Headset

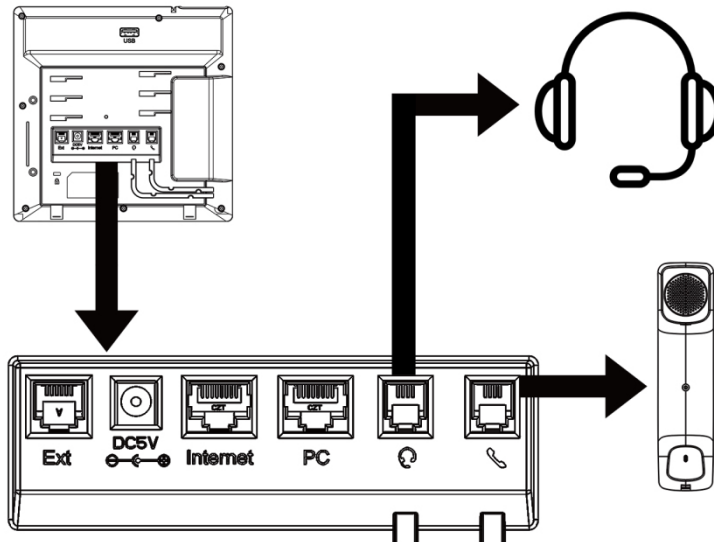

3. Connect the Network and Power

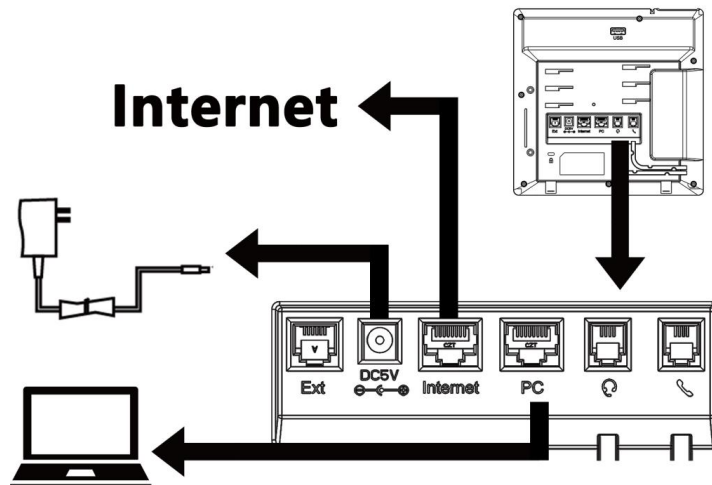

Hardware Components Preview

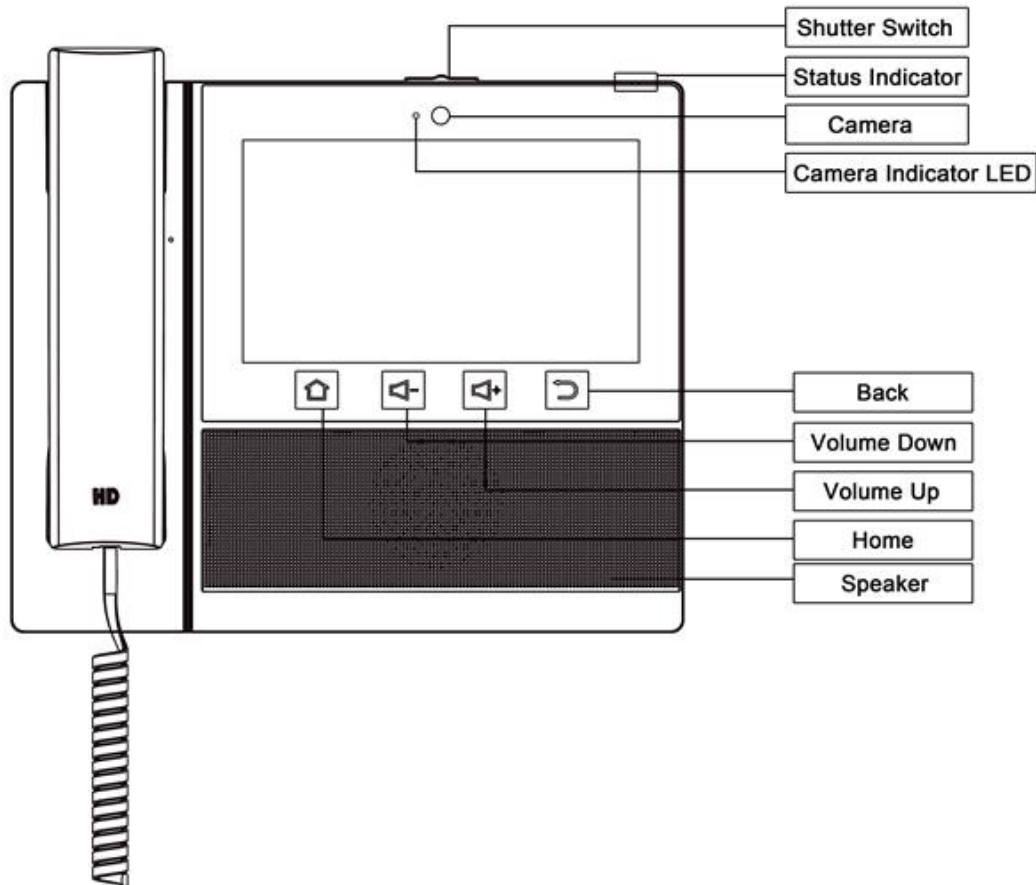

Item	Description
LCD screen	To present all information about the date& time, accounts, function icon, messages, calls and other some information.
Status Indicator	To indicate the status of phone
Shutter Switch	Adjust the shutter switch to block the camera
Camera	Labels automatically to identity their context-sensitive features.
Camera Indicator LED	Show the status of the camera
Back	Press this button back to the previous level
Volume Down	To decrease the volume.
Volume Up	To increase the volume.
Home	Return to the home page.
Speaker	Use speakers to amplify the sound

Idle Screen



Name	Description
Digital Clock Widget	It is the area that displays the current set date and time of the phone.
Menu	It is the area to display various functions of Smart phone
Status Bar	It is the area to display the phone's notifications such as missed calls, Voicè mail, do not disturb mode and many more.
Speakerphone	Press this button to place a call in hands-free mode.
Headset	To indicate that the phone is or not in Headset mode.
Mute	To mute the voice during the call (Red light). To un-mute the call.
DSS Keys	This area shows the DSS key labels. The DSS keys can also be used for other function keys.

Initialization Process

After your phone has been powered up, the system boots up and performs the following steps:

Automatic Phone Initialization.

The phone finishes the initialization process by loading the saved configuration. The phone LCD screen will display "IP PHONE".

Then show "android" during the initialization, and the home screen is displayed

Status

You can view the system status of your phone via phone user interface or web user interface. The information of phone status includes: Information (e.g., Model, IPV4, MAC, Version), Network (e.g., WAN Type, IP, Mask, LAN Type, Gateway, DNS ...), Accounts (e.g., register status of accounts)

To view the phone status via Phone interface:

1. Tap Setting→ Status→ Information or press Menu→Settings→Status→ Information
2. Tap Setting→ Status→ Network or press Menu→Settings→Status→Network
3. Tap Setting→ Status→ Network→ IPV4 or press Menu→Settings→Status→Network→ IPV4
4. Press Menu→ Status→ Accounts or press Menu→Settings→Status→Accounts

To view the phone status via Web interface:

1. Login webpage
2. Input the IP Address in the web browser.
3. Input the user name (default is admin), password (default is admin).
4. Login successfully.

View the information of Version, Account Status and Network.

Note:

The PC and phone should be in the same segment.

When registering the accounts in web and the server port is not "5060", the SIP Server should be set as SIP Server's IP address:server port, for example, 192.168.0.12:5090.

Registration

To register via Phone interface

1. Press Setting→ Advanced (default password: admin)→ Accounts or Menu→Settings→ Advanced

2. Select the desired account.
3. Select Enable for Active.
4. Select the desired Profile of the account.
5. Fill in the SIP User ID, Authenticate ID.
6. Fill in the Password and Name (shown on LCD).
7. Press Save button to save the configuration.

To register via Web interface

1. Login webpage and click Profile→ Basic
2. Select the desired profile from the pull-down list of Profile field.
3. Fill in the Primary SIP Server and other profile information.
4. Select the SIP Transport.
5. Click  to save the configuration.
6. Click Account→ Basic.
7. Select the desired account from the pull-down list of Account field.

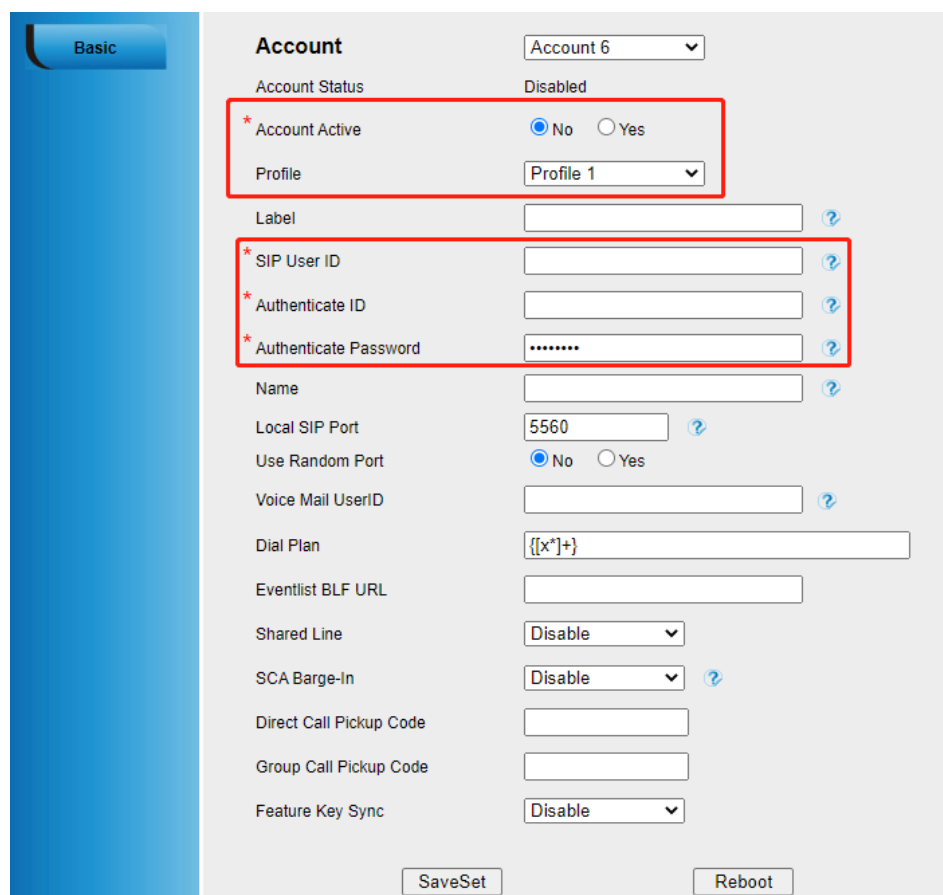

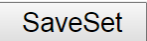

8. Select Yes for Account Active.
9. Select the desired Profile.
10. Fill in the SIP User ID, Authenticate ID, Authenticate Password and other account information.
11. Click  to save the configuration.

To register via DHCP SIP Server

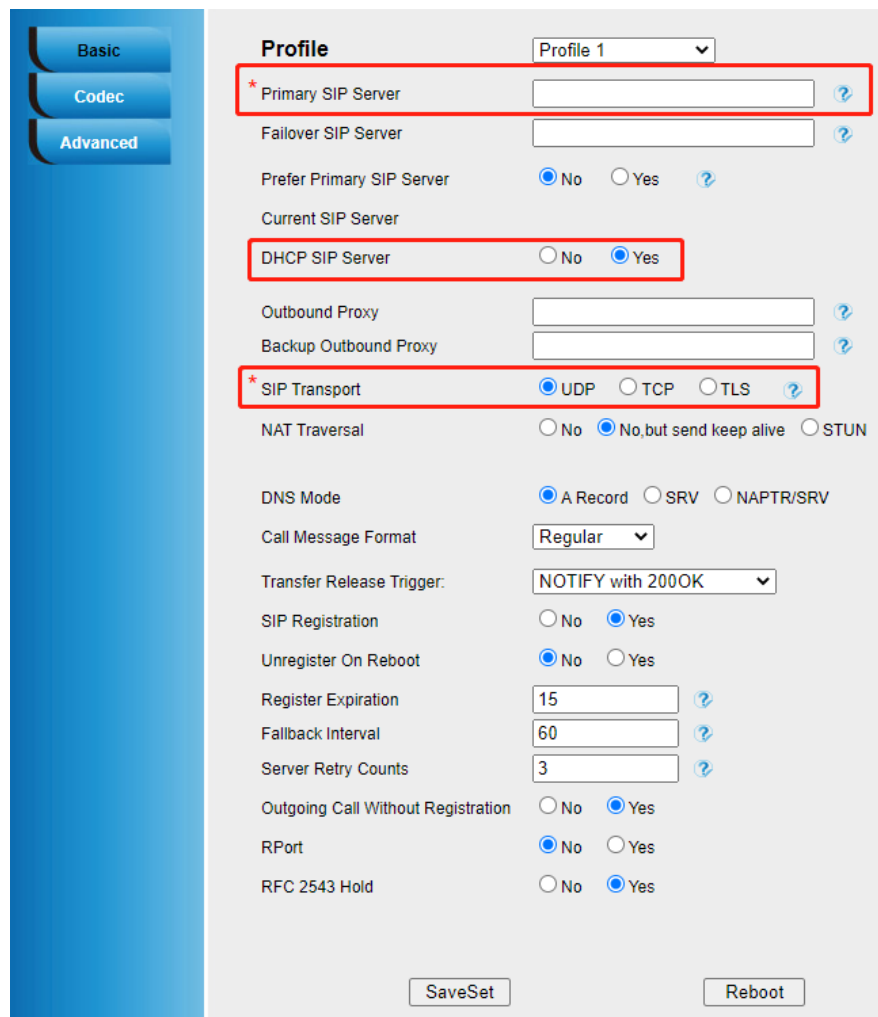
1. Login web page and Click Profile→ Basic
2. Select the desired profile from the pull-down list of Profile field.































3. Fill in the Primary SIP Server and other profile information.
4. Select Yes for the DHCP SIP Server and select the SIP Transport.
5. Click  to save the configuration.
6. Click Account→ Basic.
7. Select the desired account from the pull-down list of Account field.
8. Select Yes for Account Active.
9. Select the desired Profile.
10. Fill in the SIP User ID, Authenticate ID, Authenticate Password and other account information.
11. Click  to save the configuration.























Note:

1. All fields with * must be filled.
2. Account Status says the account registered successfully or not.

Getting Familiar with Your Phone

Icon Preview

Icon	Description	Icon	Description
	Network down		Call Park
	Line(Registered succeed)		Intercom
	Line (Unregistered)		Prefix
	Line(Ringing)		XmlGroup
	Speed Dial		LocalGroup
	BLF(No subscription)		XmlBrowser
	BLF(Free)		LDAP
	BLF(Ring)		Forward
	BLF(Talking)		Transfer
	Speakerphone mode		Redial
	Headset mode		Call Return
	Voice mail		Record
	Mute		Group Listening
	DND		Multipaging

	Hold(DSS key)		ParkRetrieve
	Line holds		Share Line
	Dialed/PickUp		URL
	Silent Calls		Wi-Fi connection is successful
	Conference		Group Pickup
	Keypad locked		XML BLF
	DTMF		BLF List
	Zero Touch		Shared Line(incoming)
	Hot Desking		Shared Line(outgoing)
	Shared Line(Idle)		Shared Line(public hold)
	Shared Line(private hold)		Shared Line(talking)
	Shared Line(seized)		

LED and Icon Instruction

This part mainly instructs the LED and Icon status. The Power LED Status describe on the premise that the LED setting all set as Yes. For LED status setting, please refer to: [LED Status Setting](#)

Power Indicator LED

LED Status	Description
Blinked red	Ringing or have missed call
Stay Green	Idle status (Power on)
Off	Powered off

Line Icon (Line Key set as Line)

Icon Status	Description
Turn into line hold icon	The call is placed on hold.
Stay Green	Off hook or during a conversation.
Dynamic line(Ringing) icon	The line receives an incoming call.
Stay Green	Idle status

BLF or BLF List Key Icon (Line/Line Key set as BLF)

Icon Status	Description
Stay Green	Idle status for the monitored line.
Stay Red (BLF Ring)	The monitored line is in the conversation or making a call.
Stay Red (BLF Talking)	The monitored line is receives an incoming call.
Stay Grey	No subscription or Account dropped.

Shared Line Icon

Icon Status	Description
Stay green	All member of the SCA group in Idle status
Stay green	a member of the SCA group in off-hook status
Stay red	Other member of the SCA group's led status when a member of the SCA group in off-hook status
Line hold	a member of the SCA group in Private hold status.
Line hold(Shared line)	Other member of the SCA group's led status when a member of the SCA group in Private hold status
Line hold	a member of the SCA group in public hold status
Line hold(Shared line)	Other member of the SCA group's led status when a member of the SCA group in public hold status
Stay green	a member of the SCA group answer a call
Stay red	Other member of the SCA group's icon when a member of the SCA group answer a call

User Interface

There are two ways to customize specific configurations on your IP phone:

- The user interface on the IP phone
- The user interface in a web browser on your PC

The hardware components and LCD screen constitute the phone user interface, which allows the user to execute all call operation tasks and basic configuration changes directly on the phone. In addition, you can use the web user interface to access all configuration settings. In many instances, it is possible to use both the phone user interface and the web user interface to operate the phone and change settings. However, in some instances, it is only possible to use the phone or the web user interface.

Phone Interface Overview

Option	
Status	Information
	Network
	Accounts
Features	Call Forward
	DSS Keys
	# Send
	Hot Line

	Call Completion
	DND
	History Record
	Call Waiting
	Auto Redial
	Intercom
Contacts	Local Contacts
	Remote Contacts(When you use remote, It will display)
	LDAP Contacts(When you use LDAP, It will display)
	BlackList
History	Sort (Time Desc/Aesc, Number Desc/Aesc)
	Type (All Calls/Missed Calls/Dialed Calls/Received Calls/Forwarded Calls)
Messages	View Voice Mail
	Set Voice Mail Code
Basic	Language & Input
	Time & Date
	Display
	Ring Tones
	Headset
	Bluetooth
	Wi-Fi
Advanced Setting	Accounts
	Profile
	Network
	Set Password
	Auto Provision
	Phone Settings

Call Features

Basic Call Features

Place a Call

There are three ways to dialing a call: Handset, Headset and Speakerphone.

To place a call by Handset:

1. Pick up the handset.

2. Enter the number.

3. Tap  to send the call

To place a call by Headset:

1. Tap  (light will be green).

2. Enter the number.

3. Tap  to send the call

Using headset to place and answer calls for all time:

1. Log into the webpage and click **Setting** → **Preference**.
2. Set **Headset Priority** to **Enable**.
3. Set **Ring Device For Headset** to **User Headset**.

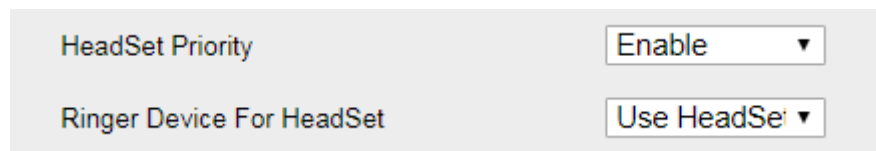

4. Click **SaveSet** to save the setting.

5. Tap  to activate the Headset priority mode.



To place a call by speakerphone:

1. Tap , or press the Line key, then you can hear the dial tone.

2. Enter the number.

3. Tap  to send the call

To place a call from Call History:

1. Press Dial application or navigate to Menu  → contacts → History .
2. Select the desired call history.

3. Tap  to send the call

To place a call from Contacts:

1. Press the Contacts icon or navigate to Menu  → contacts.
2. Select the desired contact from a contact group.



3. Tap  to send the call.

Note:

1. The  can be set as **Send** key. For more information, refer to [Key as Send](#).
2. During a call, you can also change among Handset or Speakerphone mode.

Making multiple calls

When you are in a call, you can hold your current call and place a new call.

1. Tap  to place the current call on hold.
2. Tap  .
3. Input another number,
4. Tap  to send the call

Place a Video Call

First, please confirm that the phone camera is turned on, This function requires PBX support. Please contact your administrator for confirmation.

1. Place a call as described above
2. Tap  to change to a video call

End a Call

Here shows to end a call during three modes:

To end a call by Handset

In handset mode, tap .

To end a call under Headset Mode

In headset mode, tap .

To end a call under Speakerphone Mode

In speakerphone mode, tap .

Note:

During the conference, to end the call is same as mentioned above.

Redial a Call

To redial the last placed call from the IP Phone:

Tap  in the DSS Keys

Receive a Call

There are three ways to receive a call when the phone is ringing:



To receive a call by handset

Pick up the handset.



To receive a call by headset

Tap  to receive the call

To receive a call by speakerphone

1. Option 1: Tap  to receive the call.
2. Option 2: Tap  to receive the call.

Moreover, some other action can be done by function key when the call is coming.

1. Tap  to reject the call.
2. Tap  to forward to another phone.
3. Press Silence icon, the call will stop ringing, but the incoming call notification will continue to display.

Incoming Call Show Mode

There are two incoming call show modes:

1. name of the contacts
2. name and number of the contacts

To set Incoming Call Show Mode via Web interface:

1. Click **Setting** → **Preference**.
2. Select the desired mode for the Incoming Call Show Mode.
3. Click **SaveSet**.

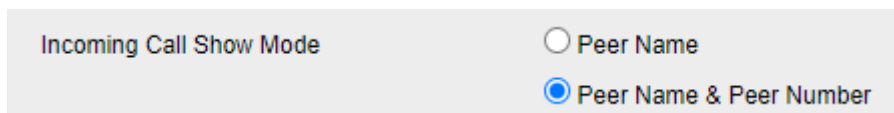

Auto Answer

Auto Answer will allow the phone answers incoming calls automatically.

To enable Auto Answer via Web interface:

1. Click **Profile** → **Advanced**.

- a) (if you want to set profile except Profile 1, please select the corresponding profile from the pull-down list in the Profile field)
2. Switch the option to **Yes**.

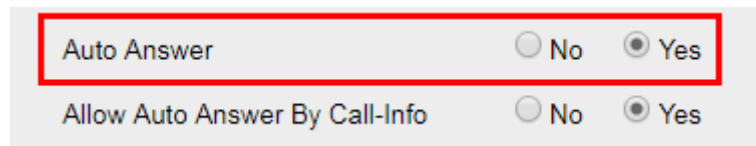



3. Click **SaveSet**.

Call Hold/Resume

When using the Hold feature, the held party may hear music played by the server.

To hold/resume a call:



1. Tap  to hold the current call.
2. Tap  to resume the call on hold.

Call Transfer

There are three transfer mode: Blind, Attended and Semi-Attended Transfer.



Blind Transfer

When you are in a call,

1. Tap  during the conversation, the call is on hold now.
2. Enter the number you want to transfer to.
3. Tap  or #, and now the blind transfer completed.



Attended Transfer

When you are in a call,

1. Tap  during the conversation, the call is on hold now.
2. Enter the number that transfer to and tap  or #, 对方接起.
3. Start the second conversation, tap  then transfer completed.

Semi-Attended Transfer

When you are in a call,

1. Tap  during the conversation, the call is on hold now.
2. Enter the number transfer to, and then tap  or #.

3. Tap  and now the Semi-attended transfer completed.

BLF Transfer

This feature controls the operation when you press the BLF key during a call. There are three modes:

- Attended Transfer
- Blind Transfer
- New Call

To set this feature, enter **Setting → Features → Transfer Settings → Transfer Mode via DSS key.**

Transfer Settings		
Blind Transfer On Hook	<input checked="" type="radio"/> On	<input type="radio"/> Off
Semi-Attended Transfer	<input checked="" type="radio"/> On	<input type="radio"/> Off
Attended Transfer On Hook	<input checked="" type="radio"/> On	<input type="radio"/> Off
Semi-Attended Transfer Mode	<input type="radio"/> On	<input checked="" type="radio"/> Off
Transfer Mode via DSSkey	Attended Transfer ▾	
Hold Transfer On Hook	<input checked="" type="radio"/> On	<input type="radio"/> Off

Relates to [BLF](#)

Override Transfer On Hook:

There are two calls at the same time, and one is in talking, another one is on held. This feature allows you to transfer the current talking call to the held call by hanging up the handset.

How to configure

1. Log into webpage, **Setting → Features → Transfer Settings → Override Transfer On Hook.**
2. Switch the option to On.
3. In the same webpage, **Setting → Features → Transfer Settings → Attended Transfer On Hook.**
4. Switch the option to On.

Transfer Settings

Blind Transfer On Hook	<input checked="" type="radio"/> On	<input type="radio"/> Off
Semi-Attended Transfer	<input checked="" type="radio"/> On	<input type="radio"/> Off
Attended Transfer On Hook	<input checked="" type="radio"/> On	<input type="radio"/> Off
Semi-Attended Transfer Mode	<input checked="" type="radio"/> On	<input type="radio"/> Off
Transfer Mode via DSSkey	Attended Transfer ▼	
Override Transfer On Hook	<input checked="" type="radio"/> On	<input type="radio"/> Off
Transfer Code Control	<input type="radio"/> On	<input checked="" type="radio"/> Off
Attend Transfer Code	<input type="text"/>	
Blind Transfer Code	<input type="text"/>	

How to use

1. A enables the Override Transfer On Hook feature.
2. During the conversation with B, A presses the Hold icon and establishes a new call with C.
3. A hung up the handset.
4. The call will transfer to C and B.

Three Way Call Release Type:

This feature allows the participants of a local conference to keep talking when the chairman leave.

How to configure

1. The chairman should login webpage, **Setting** → **Preference** → **Three Way Call Release Type** → **Transfer**.

How to use

1. There is a 3-way conference.
2. The chairman taps  to exit the conference.
3. The two participants can continue to talk.

Three Way Call Release Type

Transfer
▼

Transfer Release Trigger

This option defines the time when the phone sends BYE to the server to release the transferred call.

How to configure

- Log into webpage, **Profile** → **Basic** → **Transfer Release Trigger**.

1. NOTIFY with 200OK

After receiving REFER request send by phone, the server will send NOTIFY to the phone, and the phone response 200 OK, this is the trigger for the phone to release the call.

2. 2xx response of REFER

The phone will not release the call until it receives a 2xx response from the server to the phone's REFER request.

3. BYE for the call

The phone will not release the call until receiving BYE from the server.





Transfer Release Trigger:



Call Conference

This IP Phone supports up to 10-way audio conference.

Take the five-way conference for example:

Assuming that A and B are in conversation. A wants to bring C (or D & E) in a conference:

- 1) A taps , the call is placed on hold.
- 2) A enters the number of C and then taps  or #, C answers the call.
- 3) A taps , then A, B and C are now in a conference.
- 4) If add D&E, A taps , the current conference is on hold, taps  and dials D, D answers

the call. A taps  and  and dials E,E answers the call. A presses , then A, B, C, D, E are in conference.

Note:

1. If **C** does not answer the call, **A** can back to continue the conversation with **B**;
2. Once **A** hangs up the call, the conference is ended, while if **B** or **C** drops the call, **A&C** or **A&B** continues the conversation.
3. The conference feature is not available on all servers. For more information, contact your system administrator.
4. To realize the 5-way conference, the line should be all available.

Call Forward

This phone supports static forward (always forward, busy forward and no answer forward) and dynamic forward.

To configure static forward

To configure always/busy/no answer forward via Phone interface:

With this feature, all incoming calls will forward to configured number.

1. Tap **Forward** or Menu  → Forward

2. Select the desired forwarding type and tap  from the corresponding field.
3. Enter the Forward to number.
4. Tap Save to save the configuration.

When the Forward feature is enabled, the Icon  will display on top right of the LCD.

To configure Forward via Web interface



1. Setting→ Features
2. Click On for the Always/Busy/No Answer
3. Fill in the Target number.
4. Fill in the After Ring Time.
5. Fill in the On Code and Off Code (optional).
6. Click  to save the configuration.

Note: you should set **Feature Key Sync** to **enable** if you need to set the forward code.

To cancel the forward feature via Phone interface

1. Option 1: To tap  to disable the forward feature.

2. Option 2:

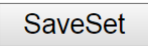

- 1) Tap **Forward** or Menu  → Forward
- 2) Select the desired forwarding type and tap  from the corresponding field.
- 3) Tap Save to save the configuration.

To cancel the forward feature via Web interface

1. Setting→ Features
2. Click Off for the Always/Busy/No Answer
3. Click  to save the configuration

To configure dynamic forward

Forward an incoming call during the ringing.

1. When the phone is ringing, tap 
2. Enter the forward number or select the desired number from Contacts(Precondition: local Contacts has one or more contacts).
3. Tap  to send the call, then the call is forwarded.

Note:

1. If the Programmable Key or line key is set as BLF, when an incoming call ringing, tap forward and BLF key directly to realize the dynamic forward.
2. You can choose a desired forward number from the Contacts when you tap the Forward key.

Call Return

This feature allows you to dial the last missed phone call.

To configure the Call Return via Phone interface

1. Tap Settings→ Features→ DSS Keys→ Line Key2(for example) or Menu  → Settings→ Features→ DSS Keys→ Line Key2(for example)
2. Tap **Type** to select the Call Return in the Type field.
3. Tap Save to save the configuration

To configure the Call Return via Web interface

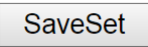
1. Click Function Keys→ Line Key.
2. Select the desired Line Key and select Call Return in the Type field.
3. Click  to save the configuration.

Line	Type	Mode	Value	Label	Account	Extension
Key1	Line	Default		243	Account 1	
Key2	Call Return	Default			Account 1	

Call Waiting Tone

To enable the Call Waiting and Call Waiting Tone via Web interface

1. Click Setting→ Features
2. Select Call Waiting: On and Call Waiting Tone: On

Call Waiting

Call Waiting On Off

Call Waiting Tone On Off

To Change the Call Waiting Tone time via Web interface

1. Click Setting→ Tones

Select Country Custom

Dial Tone

Ringback Tone

Busy Tone

Reorder Tone

Confirmation Tone

Call Waiting Tone

Syntax: f1=freq@vol, f2=freq@vol, c=on1/off1-on2/off2-on3/off3; [...]
Note: freq: 0 - 4000Hz; vol: -30 - 0dBm



2. Change the Tone Time as you want (for example 3s)

Call Waiting Tone

Call Mute

When you use the Mute feature, the other parties will not hear your voice while you can hear their voice. Call mute applies to all modes (handset, headset, and speakerphone).

To mute the call during a call (including a conference call)

1. Tap  , the icon will display  .
2. To disable the mute function, tap  again.

DND

When you use the DND feature, the phone is to reject all incoming calls automatically and you can see the DND icon  shown on the top right of the LCD on idle page.

To enable DND feature via Phone interface:

Tap **DND** when the phone is idle, and then  is shown on the top right of the LCD.

To disable DND feature via Phone interface:

Tap **DND** again, and then there is no  on the LCD.

Hot Line

To configure Hot Line via Phone interface

1. Tap Setting→ Features→Hot Line or Menu  → Settings→ Features→ Hot Line
2. Enter the Number and Hot Line Delay time (as present, we support off hook auto dial).
3. Tap Save to save the configuration

To configure Hotline auto dial via Web interface

1. Setting→ Features.
2. Fill in the number in the Hotline Number and Hotline Time-out field.
3. Click  to save the configuration.

 **HotLine**

Hotline Number

Hotline Time-out(seconds)(0~180s)

4. Delete the Hotline Number and save the configuration, then now the Hotline auto dial is cancelled.

Auto Redial

After setting this option, if the phone you are calling responds 486 Busy Here, the phone will prompt it with a busy tone (Busy Tone Timer (0~5s)), and then it will prompt Auto Redial.

To configure Auto Redial via Web interface

1. Click Setting→ Features→ Auto Redial
2. Select On or Off for the Auto Redial.
3. Fill in the number 1~300 seconds for the Auto Redial Interval.
4. Fill in the number 1~300 times for the Auto Redial Times.
5. Click to save the configuration.

Auto Redial

Auto Redial On Off

Auto Redial Interval (1~300s)

Auto Redial Times (1~300)

Note:
 If you do not want the Busy here prompt, please set Busy Tone Timer as 0. 0 means there is no busy tone.

Advanced Call Features

Call Pickup

With this feature, you can answer incoming calls someone else received.

To configure Direct Pickup code via Web interface

1. Click Account→ Basic.
2. Select the desired account from the pull-down list of Account in the Account field.
3. Fill in the Direct Call Pickup Code.
4. Click to save the configuration.

Direct Call Pickup Code

To configure Direct Pickup feature via Phone interface

1. Tap Setting→ Features→ DSS Keys→ Line Key2(for example) or Menu  → Settings→ Features→ DSS Keys→ Line Key2(for example)
2. Select the Pickup in the Type field.
3. Enter the targeted Number in the Value field.
4. Select the Account ID.
5. Tap **Save** to save the configuration, then the selected Line Key will work as Direct Pickup.

To configure Direct Pickup feature via Web interface

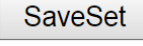
1. Click Function Keys→ Line Key.
2. Select the wanted Line Key and set as Direct Pickup.
3. Enter the desired phone number in the Value field.
4. Select the Account
5. Click  to save the configuration.

Line	Type	Mode	Value	Label	Account	Extension
Key1	Line	Default			Account 1	
Key2	Direct Pickup	Default	*20*137		Account 1	

Group Pickup

With this feature, you can pick up the specified group that you want incoming calls.

To configure Group Pickup code via Web interface

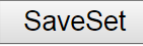
1. Click Account→ Basic.
2. Select the desired account from the pull-down list of Account in the Account field.
3. Fill in the Group Call Pickup Code
4. Click  to save the configuration.

Group Call Pickup Code

To configure the Group Pickup via Phone interface

1. Tap Setting→ Features→ DSS Keys→ Line Key2(for example) or Menu  → Settings→ Features→ DSS Keys→ Line Key2(for example)
2. Select the GroupPickup in the Type field.
3. Enter the targeted Number in the Value field.
4. Select the Account ID.
5. Tap **Save** to save the configuration

To configure the Group Pickup via Web interface

1. Click Function Keys→ Line Key.
2. Select the desired Line Key and select Group Pickup in the Type field.
3. Enter the desired phone number in the Value field.
4. Select the Account
5. Click to save the configuration.

Line	Type	Mode	Value	Label	Account	Extension
Key1	Line	Default		243	Account 1	
Key2	Group Pickup	Default	8038		Account 2	

Call Park

With this feature, you can put a call on hold and continue the conversation from another phone.

To configure the Call Park via Phone interface

1. Tap Setting→ Features→ DSS Keys→ Line Key2(for example) or Menu  → Settings→ Features→ DSS Keys→ Line Key2(for example)
2. Select the Call Park in the Type field.
3. Enter the call park code in the Value field
4. Select the Account ID.
5. Tap **Save** to save the configuration.

To configure the Call Park via Web interface

1. Click Function Keys→ Line Key.
2. Select the desired Line Key and select Call Park in the Type field.
3. Enter the call park code in the Value field.
4. Select the Account.
5. Click the button to save the configuration.

Line	Type	Mode	Value	Label	Account	Extension
Key1	Line	Default		088	Auto	
Key2	Call Park	Default	SP10		Account 1	

Busy Lamp Field (BLF)

You can use the BLF (Busy Lamp Field) feature to monitor a specific extension number whether the extension is busy or free.

1. When the extension you are monitoring is idle, the icon is steady green.
2. When the monitored extension is ringing, the icon is red, press the BLF key to pick the phone up directly.
3. When the monitored extension is calling or in a conversation, the icon is steady red.

To configure a BLF key via Phone interface

1. Tap Setting → Features → DSS Keys → Line Key2(for example) or Menu  → Settings → Features → DSS Keys → Line Key2(for example).
2. Select the BLF in the Type field.
3. Enter the targeted Number in the Value field.
4. Select the Account ID.
5. Enter the Pickup Code.
6. Select Save to save the configuration

To configure a BLF key via Web interface

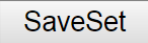
1. Click Function Keys → Line Key.
2. Select the desired Line Key and select BLF in the Type field.
3. Enter the monitored phone number in the Value field.
4. Select the Account
5. Fill in the Extension.
6. Click  to save the configuration.

Line	Type	Mode	Value	Label	Account	Extension
Key1	Line	Default		243	Account 1	
Key2	BLF	Default	245		Account 1	

Note:
 This feature is not available on all servers. For more information, contact your system administrator.
 After setting the BLF key, do not need to restart the phone.

Visual Alert for BLF Pickup

If this option is on, when you use the BLF feature to monitor a specific phone whether it is busy or free, you can see this message on the LCD, as shown in the following figure.

To configure Visual Alert for BLF Pickup via Web interface

1. Click Setting → Features → Call Pickup → Visual Alert for BLF Pickup
2. Select Enable or Disable for Visual Alert for BLF Pickup.

3. Click to save the configuration.

Call Pickup

Call Pickup Mode

Direct Call Pickup

Direct Call Pickup Code

Group Call Pickup

Group Call Pickup Code

Visual Alert for BLF Pickup

Audio Alert for BLF Pickup

To configure BLF via Web interface

1. Click Function Keys→ Line key
2. Select the desired Line.
3. Type selection as BLF.
4. Fill in the required BLF value.
5. Fill in the required pickup code for the extension number.
6. Click to save the configuration.

Line	Type	Mode	Value	Label	Account	Extension
Key1	Line	Default			Account 2	
Key2	BLF	Default	1025		Account 2	*04

Audio Alert for BLF Pickup

If this option is on, when you use the BLF feature to monitor a specific phone whether it is busy or free, you can hear beep.

To configure Audio Alert for BLF Pickup via Web interface

1. Click Setting→ Features→ Call Pickup→ Audio Alert for BLF Pickup
2. Select Enable or Disable for Audio Alert for BLF Pickup.
3. Click to save the configuration.

Call Pickup

Call Pickup Mode: FAC

Direct Call Pickup: Disable

Direct Call Pickup Code:

Group Call Pickup: Disable

Group Call Pickup Code:

Visual Alert for BLF Pickup: Disable

Audio Alert for BLF Pickup: Enable

BLF List

To configure BLF List via Web interface:

1. Login and click Account→ Basic
2. Select the desired account from the pull-down list of Account in the Account field.
3. Fill in the Eventlist BLF URL.

Eventlist BLF URL

4. Click Profile→ Advanced
5. Select the desired profile from the pull-down list of Profile in the Profile field.
6. Select the SIP Server Type

SIP Server Type: BroadSoft

7. Click to save the configuration.

8. To configure BLF List Keys

- 8.1 Click Function Keys→ Line Key
- 8.2 Select the desired Line Key and select the BLF List in the Type field.
- 8.3 Select the Account

- 8.4 Click to save the configuration.

Line	Type	Mode	Value	Label	Account	Extension
Key1	Line	Default	<input type="text"/>	243	Account 1	<input type="text"/>
Key2	BLF List	Default	<input type="text"/>	<input type="text"/>	Account 1	<input type="text"/>

Shared Line

IP Phone supports “Shared Call Appearance” by Broadsoft and XCast standard. This feature allows members of the SCA group to shared SIP lines and provides status monitoring (idle, active, progressing, hold) of the shared line. When there is an incoming call designated for the SCA group, all of the members of the group will be notified of an incoming call and will be able to answer the call from the phone with the SCA extension registered in the group.

All the users that belong to the same SCA group will be notified by visual indicator when a user seizes the line and places an outgoing call, and all the users of this group will not be able to seize the line until the line goes back to an idle state or when the call is placed on hold (with the exception of when multiple call appearances are enabled on the server side).

In the middle of the conversation, there are two types of hold: Public Hold and Private Hold. When a member of the group places the call on public hold, the other users of the SCA group will be notified of this by the red-flashing button and they will be able to resume the call from their phone by pressing the line button. However, if this call is placed on private-hold, no other member of the SCA group will be able to resume that call. To enable shared call appearance, the user would need to register the shared line account on the phone. In addition, they would need to navigate to “Account” → “Basic” and “Profile” → “Advanced” on the webpage and set the line to “Shared Line” and “SIP Server Type”, and configure the line key or Line Key as “Line” type with the desired account on webpage or LCD. If the user requires more shared call appearances, the user can configure multiple line keys (Function Keys → Line Key) to be “Line” type associated with the account.

This feature is very useful in the boss and secretary scenario. For example, the secretary can share the boss' extension number on her phone. When there is an incoming call to the extension number of the boss, both the phones of the boss and the secretary will ring simultaneously. Either the boss or the secretary can answer the call. Calls on shared line can be placed on hold or barged in.

To enable share line via Web interface

1. Click Account → Basic
2. Select the desired account from the pull-down list of Account in the Account field.
3. Select SCA for the Shared Line.

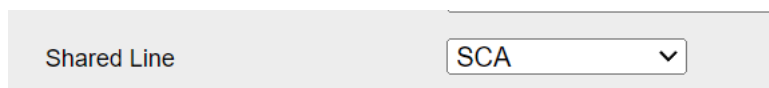

Shared Line

4. Click Profile → Advanced
5. Select the desired profile from the pull-down list of Profile in the Profile field.
6. Select the SIP Server Type.

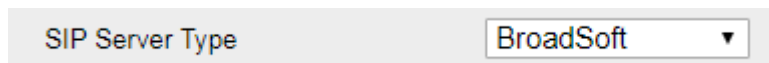

SIP Server Type

7. Click to save the configuration.

To configure Line key via Phone interface

1. Tap Settings→ Features→ DSS Keys→ Line Key2(for example) or Menu  → Settings→ Features→ DSS Keys→ Line Key2(for example)
 2. Select the Line in the Type field.
 3. Select the Account ID.
 4. Tap **Save** to save the configuration.
- Then the selected Line Key will work as Line.

To configure Line key via Web interface

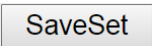
1. Click Function Keys→ Line Key.
2. Select the wanted Line Key and set as Line.
3. Select the Account.
4. Click the  button to save the configuration.

Line	Type	Mode	Value	Label	Account	Extension
Key1	Line ▼	Default ▼		243	Account 1 ▼	
Key2	N/A ▼	Default ▼			Account 1 ▼	

Note:
 This feature is not available on all servers. For more information, contact your system administrator.

Intercom

When use the intercom feature, you can quickly get access connect to the configured one.

To configure Intercom feature via Phone interface

1. Tap Setting→ Features→ DSS Keys→ Line Key2(for example) or Menu  → Settings→ Features→ DSS Keys→ Line Key2(for example).
 2. Select the Intercom in the Type field.
 3. Enter the intercom codes followed by desired number.
 4. Select the Account ID.
 5. Tap Save to save the configuration.
- Then the selected Line Key will work as Intercom.

To configure Intercom feature via Web interface

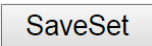
1. Click Function Keys→ Line Key.
2. Select the wanted Line Key and set as Intercom.
3. Enter the intercom codes followed by desired number in the Value field.
4. Select the Account.
5. Click the  button to save the configuration.

Line	Type	Mode	Value	Label	Account	Extension
Key1	Line	Default		088	Auto	
Key2	Intercom	Default	*11012		Account 1	

If you want to achieve the Intercom feature, you must enable the “Allow Auto Answer by Call-Info”

1. Login webpage, and click Profile→ Advanced
2. Select the desired profile from the pull-down list of Profile in the Profile field.
3. Select Yes for the “Allow Auto Answer By Call-Info”
4. Click the button to save the configuration.

Allow Auto Answer By Call-Info No Yes

Note:
This feature is not available on all servers. For more information, contact your system administrator.

Intercom Barge

If this option is enabled, when there is an active call and an incoming intercom call arrives, the previous call will be put on hold and the intercom call will be answered.

1. Login webpage, and click Setting→ Preference
2. Set On or Off for Intercom Barge.
3. Click for the setting.

Intercom Barge On Off

Note:
This feature is not available on all servers. For more information, contact your system administrator.

Voice Mail

This phone supports voicemail, and when there is a message, you can tap **Message** to listen to voice Mail. Text Notify will be displayed on the LCD of the phone.

To configure the Voice Mail feature via Phone interface:

1. Tap **Message**→ Voice Mail→ Set Voice Mail.
2. Enter the voice mailbox number corresponding to the account.

3. The input will be saved automatically

To configure the Voice Mail feature via Web interface:

1. Click Account→ Basic.
2. Select the desired account from the pull-down list of Account in the Account field.
3. Fill in the Voice Mail UserID.
4. Click to save the configuration.



The screenshot shows a text input field labeled "Voice Mail UserID" with a question mark icon to its right.

To configure a Voice Mail key via Phone interface:

1. Tap Setting→ Features→ DSS Keys→ Line Key2(for example) or Menu  → Settings→ Features→ DSS Keys→ Line Key2(for example).
2. Select the Voice Mail in the Type field.
3. Enter the targeted feature codes in the Value field.
4. Select the Account ID.
5. Tap **Save** to save the configuration.

To configure a Voice Mail Key via Web interface:

1. Click Function Keys→ Line Key.
2. Select the wanted Line Key and set as Voice Mail.
3. Enter the desired voicemail feature codes in the Value field.
4. Select the Account.
5. Click to save the configuration.

Line	Type	Mode	Value	Label	Account	Extension
Key1	Line	Default		243	Account 1	
Key2	Voice Mail	Default	*97		Account 1	

To leave a voice mail:

You can leave a voice mail when the receiver is busy or its inconvenient for them to answer the call. Follow the voice prompt from the system server to leave a voice mail, and then hang up.

To listen to voice mails:

When the phone interface prompts receiving new voice mail's icon, the power indicator LED flashes red(Setting→ Preference→ LED Status Setting: Voice Message Status: Yes) and there will be relevant text at the status bar.

1. Tap **Message** or the targeted Line Key to dial out the voice mail access code.
2. Follow the voice prompt to listen to voice mail.

To view the voicemail via Phone interface:

Tap **Message** → View Voice Mail

The LCD screen displays the amount of new and old voice mails.

Note:

1. This feature is not available on all servers. For more information, contact your system administrator.
2. Before listening to voice mails, make sure the voice mail access code has been configured.
3. When all new voice mails are retrieved, the power indicator LED will turn green and the relevant text will clear.

Using the Hot Desking

Hot Desking

Hot Desking originates from the definition of being the temporary physical occupant of a workstation or surface by a particular employee. A primary motivation for Hot Desking is cost reduction. This feature is regularly used in places where all employees are not in the office at the same time, or not in the office for a very long time, which means their personal offices are often vacant, consuming valuable space and resources.

You can use Hot Desking on the IP phone to logout the existing accounts and then log in a new account, which allows many users to share the phone resource in different times. To use this feature, first you need to configure a Hot Desking key in the advance settings.

To configure the Hot Desking via Phone interface

1. Tap Setting→ Features→ DSS Keys→ Line Key2(for example) or Menu  → Settings→ Features→ DSS Keys→ Line Key2(for example).
2. Select the Hot Desking in the Type field.
3. Tap **Save** to save the configuration.

To configure the Hot Desking via Web interface:

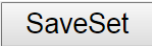
1. Click Function Keys→ Line Key.
2. Select the desired Line Key and select Hot Desking in the Type field.
3. Click the  button to save the configuration.

Line	Type	Mode	Value	Label	Account	Extension
Key1	Line ▼	Default ▼		243	Account 1 ▼	
Key2	Hot Desking ▼	Default ▼			Account 1 ▼	

To use the Hot Desking feature on the user interface:

1. Tap the Hot Desking key when the IP Phone is idle.
2. "Clear all other account config?" is shown on the screen and tap confirm.
2. Enter the Extension number and password
3. Click Save button

You can see the account information which has changed.

Note:

This feature is not available on all servers. For more information, contact your system administrator.

Contacts

This section provides the operating instructions for managing contacts. The topics include:

- Local Contacts
- Remote Phonebook
- LDAP
- Black List

Local Contacts



In the Contacts, you can add or delete your friends, business partner or anyone others' phone No., so that you will not forget their number. Or put some anonymous phone No. in the blacklist to prevent from being disturbed. The local Contacts can add up to 10000 contacts.

Contact Groups

Adding Contact Groups

To organize your contacts and make them easier to find, you can add additional groups in the Local Contacts.



To Add Contact Group in the Local Contacts

1. Tap Contacts or Menu  → Contacts.
2. Tap Settings  .
3. Tap  to add a new group.
4. Enter the Group Name and select Ring Tone.
5. Tap **Save** to save the configuration.

Editing Contact Groups

You can change or add the group's information.



To edit Contact Group in the Local Contacts

1. Tap Contacts or Menu  → Contacts.
2. Tap Settings  .
3. Select a group (The default Contacts group cannot be edited)
4. tap  to edit.
5. Edit the group information.
6. Tap **Save** to save the configuration.

Deleting Contact Groups

When deleting a contact group, the Contacts group will not be deleted.

To delete Contact Group in the Local Contacts

1. Tap Contacts or Menu  → Contacts.
2. Tap Settings  .
3. Select a group (The default Contacts group cannot be edited).
4. Tap  to delete.



Managing the Local Contacts

You can manage the Local Contacts contacts when the phone is idle.





Adding Contacts

After adding a contact to the local Contacts, you can choose to enter relevant information for the contact. At a minimum, you need to enter the contact's name and number for each new contact.

To Adding Contacts via Phone interface

1. Tap Contacts or Menu  → Contacts.
2. Select the desired contact group or Contacts.
3. Tap  in the lower right corner.
4. Enter your contact's information. (Name and Number cannot be empty).
5. Tap **Save** to save the configuration.

To add contacts from history via Phone interface:

1. Tap Contacts →  or Menu  → Contacts → .
2. Select the targeted one.
3. Tap **Add Contacts** .
4. Edit the necessary information as Name, Phone number...
5. Tap **Save** to add the contacts successfully.

To add contacts via Web interface:

1. Click Directory → Directory
2. Enter the name, number and some other information.
3. Press and then press button.

Contact
BlackList

Index	Display Name	Office Number	Mobile Number	Other Number	Account	All
1	tom	028			Auto	

Hangup
Save
Delete
Move to Contact/blacklist

Contact

Name

Office Number

Mobile Number

Other Number

Account

Ring

Group

Photo

Add
Edit
Search

Delete Photo

Browse... No file selected.

Upload Photo

Import Local Contacts

Browse... No file selected.

Viewing Contacts

To view Contacts in the Local Contacts:

1. Tap Contacts or Menu → Contacts.
2. Select the desired contact group or Contacts.

Editing Contacts

You can update your contacts' information.

To edit Contacts in the Local Contacts:



1. Tap Contacts or Menu → Contacts.
2. Select the desired contact group or Contacts.
3. Find the contact item you want to edit.
4. Tap and press edit in the upper right corner.

5. Edit the contact information (Name, Number).
6. Tap **Save** to save the configuration.

Deleting a Contact

You can delete any contact from the Local Contacts.





To delete Contacts in the Local Contacts:

1. Tap Contacts or Menu  → Contacts.
2. Select the desired contact group or Contacts.
3. Find the contact item you want to delete.
4. Tap  and press  delete in the upper right corner.
5. And prompt “Are you sure to delete this item?”.
6. Tap **Save** to save the configuration.

Moving a Local Contact to Blacklist

You can move a contact in the Local Contacts to blacklist. Incoming calls from this contact will be rejected automatically.



To move a local Contacts to Blacklist:

1. Tap Contacts or Menu  → Contacts.
2. Select the desired contact group or Contacts.
3. Find the contact item you want to edit.
4. Tap  and press  edit in the upper right corner.
5. Turn on the switch  corresponding to the blacklist item
6. Tap **Save** to save the configuration.

Searching for Contacts

In the Local Contacts, you can enter search criteria to find your desired contact quickly.



To search contacts in the local contacts:

1. Tap Contacts or Menu  → Contacts.
2. Tap Search  , Enter your search criteria in the search field.

To import or export the contact list

You can manage your phone's local contacts via phone or web user interface. But you can only import or export the contact list via Web interface.

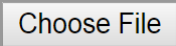
To import an XML file of contact list via Web interface:

1. Click on Directory→ Directory
2. Click  to select a contact list file (file format must be .xml) from your local system.
3. Click  to import the contact list.

To export an XML file of contact list via Web interface:

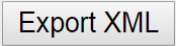
1. Click on Directory→ Directory
2. Click  to export the contact list.

To import a CSV file of contact list via Web interface:

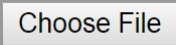
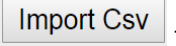
1. Click on Directory→ Directory
2. Click  to select a contact list file (file format must be .csv) from your local system.
3. Click  to import the contact list.

To export a CSV file of contact list via Web interface:

1. Click on Directory→ Directory
2. Click  to export the contact list.

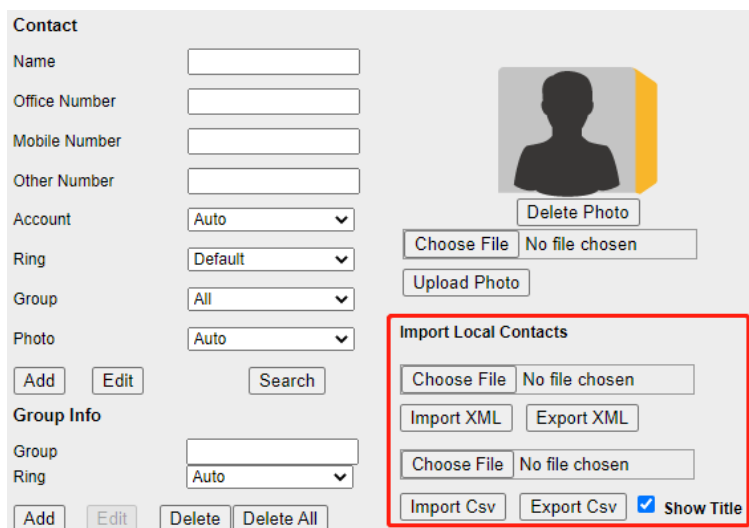

Note:
If the XML file or CSV file has more than 10000 contacts, the phone will only upload 10000 contacts.



Blacklist

Incoming calls from the Blacklist are rejected automatically.

Adding a Blacklist Contact

You can add a blacklist contact on the phone to prevent someone from calling you.

To add a blacklist contact via phone interface:

1. Tap Contacts→Blacklist or Menu  → Contacts→Blacklist.
2. Tap  in the lower right corner to add a new item.
3. Enter the desired value (Name, Number...)
4. Tap **Save** to save the configuration.

To add a blacklist contact via web interface:

1. Click the webpage->Directory->Directory -> BlackList
2. Fill in the desired value in the contact (Name, Number).
3. Click **Move to contact/blacklist** button and save the configuration.

Viewing Blacklist Contacts

You can view the blacklist contacts from the Blacklist on your phone.

To view blacklist contact via phone interface:

1. Tap Contacts or Menu  → Contacts→Blacklist.

Deleting Blacklist Contacts



You can delete one or all blacklist contacts. If a contact is removed from the blacklist, you can answer the call from the contact normally.

Deleting a Blacklist Contact

If you want to answer a call from a specific contact, you need to remove it from the Blacklist.

To delete blacklist contact via phone interface:





1. Tap Contacts or Menu  → Contacts→Blacklist.

2. Select the desired contact items.
3. Tap  and press  delete in the upper right corner.
4. And prompt “Are you sure to delete this item?”.
5. Press yes to confirm deletion.

Moving a Blacklist Contact to the Local Contacts

You can move a blacklist contact to a Local Contacts. Incoming calls from this contact will not be rejected automatically.

To move a blacklist contact to the Local Contacts via phone interface:

1. Tap Contacts or Menu  → Contacts→Blacklist.
2. Select the desired contact items.
3. Tap  and press edit  in the upper right corner.
4. Turn off the switch  corresponding to the blacklist item
5. Tap **Save** to save the configuration.

To move a blacklist contact to the Local Contacts via web interface:

1. Click the webpage->Directory->Directory -> BlackList
2. Select the contact you want to remove.
3. Click the Move to Contact/blacklist.

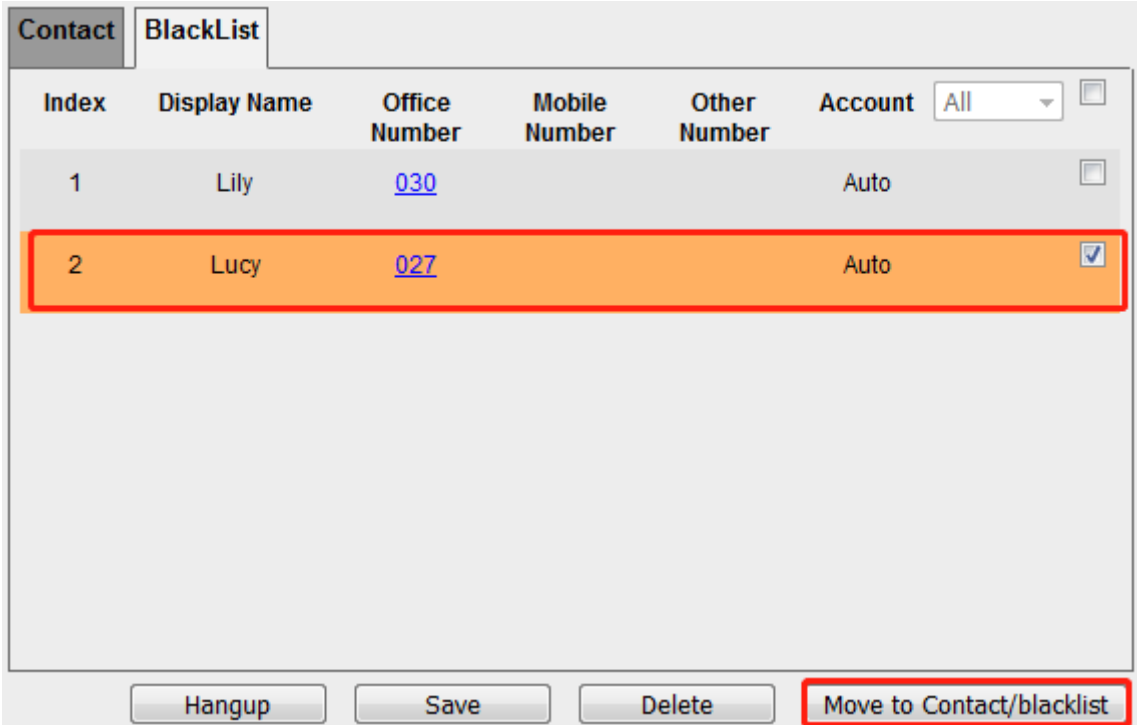

Index	Display Name	Office Number	Mobile Number	Other Number	Account	All	<input type="checkbox"/>
1	Lily	030			Auto		<input type="checkbox"/>
2	Lucy	027			Auto		<input checked="" type="checkbox"/>

Buttons: Hangup, Save, Delete, **Move to Contact/blacklist**

Remote Phonebook

To set Remote Phonebook via Web interface:

1. Login the webpage and click Directory→ Remote Phone Book
2. Fill in the URL of the remote file in the Phone Book URL field. For example, `http://10.2.0.140/Phonebook/remotephonebook.xml`
3. Fill in the Name and then click to save the configuration.

Index	PhoneBook URL	Name
1	<input type="text" value="http://10.2.0.140/Phonebook/remotephoneboc"/>	<input type="text" value="test1"/>
2	<input type="text"/>	<input type="text"/>
3	<input type="text"/>	<input type="text"/>
4	<input type="text"/>	<input type="text"/>
5	<input type="text"/>	<input type="text"/>



Update Time Interval(minutes) 

To check the contacts via Phone interface:

1. Tap Contacts or Menu  → Contacts→ Remote Contacts, and then you can see the item you set.
2. Select the item and it will automatically update and show the detail.

Note:
Every remote phonebook, only supports 10000 contacts.

To search contact in Remote Contacts:

1. Tap Contacts or Menu  → Contacts→ Remote Contacts.
2. Select the desired remote phonebook.
3. Tap Search , you can enter the desired part of name or part of number.
4. With the search content to match the contact will be automatically displayed on the LCD.

LDAP Phonebook

When use the LDAP feature, you can get the LDAP Phonebook directly.

To configure LDAP via Web interface:

1. Login webpage and click Directory→ LDAP
2. Fill in the LDAP Name Filter:
 - a) This parameter specifies the name attributes for LDAP searching. The “%” symbol in the filter stands for the entering string used as the prefix of the filter condition.
 - b) For example, (cn=%), when the name prefix of the cn of the contact record matches the search criteria, the record will be displayed on the IP PHONE LCD.
3. Fill in the LDAP Number Filter: This parameter specifies the number attributes for LDAP searching.
4. Fill in Server Address: Fill in the domain name or IP address of the LDAP Server. For example: 192.168.0.253
5. Port (the port of the LDAP Server), Base, User Name, Password
6. Max.Hits(1-32000): the maximum number of the search results to be returned by the LDAP server.
7. LDAP Display Name: the display name of the contact record displayed on the LCD screen.
8. Filled in the relative value and then click to save the settings.

Following is the example screenshot for the configuration.

LDAP Name Filter	<input type="text" value="(cn=%)"/>	?
LDAP Number Filter	<input type="text" value="((telephoneNumber=%)"/>	?
Server Address	<input type="text" value="192.168.0.107"/>	?
Port	<input type="text" value="389"/>	?
Base	<input type="text" value="dc=pbx,dc=com"/>	?
User Name	<input type="text" value="cn=admin,dc=pbx,dc=cc"/>	?
Password	<input type="password" value="●●●●●●"/>	?
Max.Hits(1~32000)	<input type="text" value="32000"/>	?
LDAP Name Attributes	<input type="text"/>	?
LDAP Number Attributes	<input type="text"/>	?
LDAP Display Name	<input type="text" value="cn"/>	?
Protocol	<input checked="" type="radio"/> Version2 <input type="radio"/> Version3	?
LDAP Lookup For Call	<input type="radio"/> On <input checked="" type="radio"/> Off	?
LDAP Sorting Results	<input type="radio"/> On <input checked="" type="radio"/> Off	?
LDAP Synchronize Time(0~9999mins)	<input type="text"/>	?

To configure LDAP Key via Web interface:



1. Click Function Keys→ Line Key→ choose Line Key2(for example)
2. Select LDAP in the Type field.
3. Click to save the configuration.

Line	Type	Mode	Value	Label	Account	Extension
Key1	Line	Default		243	Account 1	
Key2	LDAP	Default			Account 1	

To Configure LDAP Key via Phone interface:

1. Tap Settings→ Features→ DSS Keys→ Line Key2(for example) or Menu → Settings→ Features→ DSS Keys→ Line Key2(for example)
2. Tap **Type** to select the LDAP in the Type field.
3. Tap **Save** to save the configuration.

To search contact in LDAP contacts:

1. Tap Contacts or Menu  → Contacts→ LDAP Contacts.
2. Tap Search , you can enter the desired part of name or part of number.
3. With the search content to match the contact will be automatically displayed on the LCD within 5 seconds.

Recent Calls Setting





Recent Calls

This phone maintains call history lists of Dialed Calls, Received Calls, Missed Calls and Forwarded Calls. Each call log list supports up to 1000 entries. You can check the call history, dial a call, add a contact or delete an entry from the call history list. You should enable the history record feature in advance.





To enable the history record feature via Phone interface:

1. Tap Settings→ Features→ History Record or Menu  → Settings→ Features→History Record
2. Set History record: On.
3. Tap Save to save the configuration.

To view the Recent Calls via Phone interface:



1. Tap **Contacts**→Recent Calls  or Menu  →Contacts→Recent Calls  .
The LCD screen displays All Calls list.
2. Tap  to switch among All Calls, Missed Calls, Received Calls, Dialed Calls and Forwarded Calls.
3. Select the desired item.
4. The detailed information of the entry appears on the LCD screen.

To Dial a call from Recent Calls via Phone interface:





1. Tap **Contacts**→History  or Menu  →Contacts→History  .
2. Tap  to switch among All Calls, Missed Calls, Received Calls, Dialed Calls and Forwarded Calls.
3. Tap the desired item and dial out.

To delete an entry from the Recent Calls list via Phone interface:





1. Tap **Contacts**→History  or Menu  →Contacts→History  .

2. Tap  to switch among All Calls, Missed Calls, Received Calls, Dialed Calls and Forwarded Calls.
3. Select the desired item.
4. Tap delete  icon.
5. Tap confirm to delete it.

To delete all entries from the Recent Calls list via Phone interface:

1. Tap **Contacts**→History  or Menu  →Contacts→History .
2. Tap  to switch among All Calls, Missed Calls, Received Calls, Dialed Calls and Forwarded Calls.
3. Tap the delete icon .
4. Tap confirm to delete it.

To add to Local Contacts from Recent Calls via Phone interface:

1. Tap **Contacts**→History  or Menu  →Contacts→History .
2. Select the desired one.
2. Tap add icon .
3. Edit the necessary information as Name, Phone number...
5. Tap **Save** to add successfully.

To check the call history via Web interface:

1. Click Directory→ Call History
2. Click Dialed List, Missed List, Received List, or Forwarded List, then you can see the history list.

Dialing List						
Dialing List		Missed List		Received List		Forwarded List
Index	Date	Time	Local Identity	Name	Tel Number	
1	05-07-2019	05:26:21		amy	013	
2	05-07-2019	04:39:40		004	004	
3	03-04-2019	07:34:57		1105	1105	
4	03-04-2019	07:33:43		1105	1105	
5	03-04-2019	07:32:23		1105	1105	
6	03-04-2019	07:31:09		1105	1105	
7	03-04-2019	07:29:55		1105	1105	
8	03-04-2019	07:28:41		1105	1105	
9	03-04-2019	07:27:27		1105	1105	
10	03-04-2019	07:26:13		1105	1105	
11	03-04-2019	07:24:59		1105	1105	
12	03-04-2019	07:23:45		1105	1105	
13	03-04-2019	07:22:31		1105	1105	
14	03-04-2019	07:21:17		1105	1105	
15	03-04-2019	07:20:02		1105	1105	
16	03-04-2019	07:18:48		1105	1105	
17	03-04-2019	07:17:34		1105	1105	
18	03-04-2019	07:16:09		1105	1105	

Export XML Export Csv

To Dial a call from Recent Calls via Web interface:

1. Click Directory→ Call History
2. Select the desired history item and click Tel Number.
3. Then the call is dialed on phone.

Dialed List		Missed List		Received List		Forwarded List	
Index	Date	Time	Local Identity	Name	Tel Number		
1	05-07-2019	05:26:21		amy	013		
2	05-07-2019	04:39:40		004	004		
3	03-04-2019	07:34:57		1105	1105		
4	03-04-2019	07:33:43		1105	1105		
5	03-04-2019	07:32:23		1105	1105		
6	03-04-2019	07:31:09		1105	1105		
7	03-04-2019	07:29:55		1105	1105		
8	03-04-2019	07:28:41		1105	1105		
9	03-04-2019	07:27:27		1105	1105		
10	03-04-2019	07:26:13		1105	1105		
11	03-04-2019	07:24:59		1105	1105		
12	03-04-2019	07:23:45		1105	1105		
13	03-04-2019	07:22:31		1105	1105		
14	03-04-2019	07:21:17		1105	1105		
15	03-04-2019	07:20:02		1105	1105		
16	03-04-2019	07:18:48		1105	1105		
17	03-04-2019	07:17:34		1105	1105		
18	03-04-2019	07:16:09		1105	1105		

Export XML Export Csv

Audio Settings

Ring Tone

You can adjust the type and volume of the ring tone.

To adjust the Ring Tone Type via Phone interface:

1. Tap **Settings** → Basic or Menu  → Settings → Basic → Ring Tones.
2. Select the aimed one.
3. Tap Save to save the configuration.

To adjust the Ring Tone Type via Web interface



1. Setting → Preference → Ring Tones

2. Select the wanted one and enter the Ring Volume

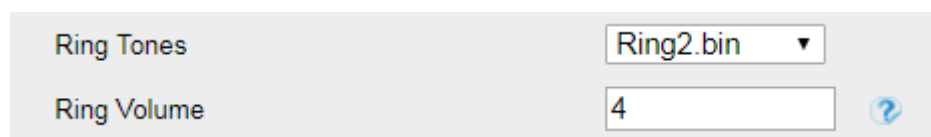
3. Click  to save the configuration.



To configure Distinctive Ring Tone via Phone interface

1. Tap **Contacts** or Menu  →Contacts
2. Find the target contact.
3. Tap  at the end of the contact entry
4. Tap edit  in the upper right corner
5. Select the ring tone you want in Ring

To configure Distinctive Ring Tone via Web interface

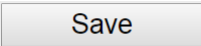
1. Directory→ Directory→ Contact
2. Select the target contact.
3. Choose the Ring Tone you want to use.
4. Click  →  to save the configuration.

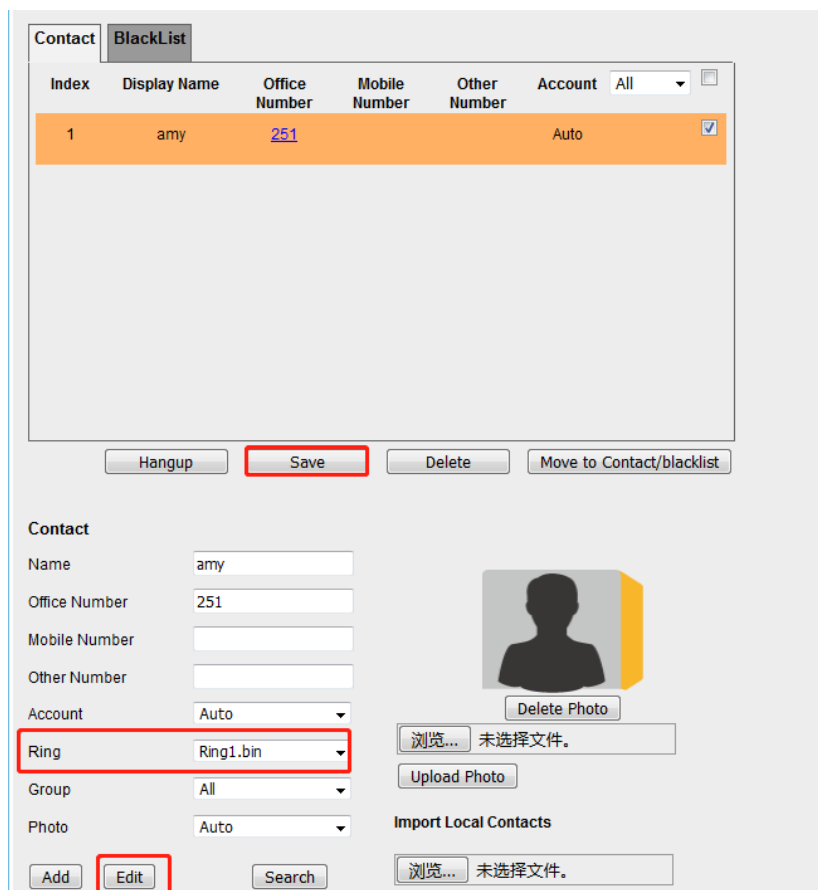

Volume

You can adjust the volume for the phone by the volume keys:

To adjust the Ring tone volume via Phone interface:

1. Option 1: To press side volume keys on the idle page
2. Option 2: To press side volume keys during the call is ringing.

To adjust the handset volume via Phone interface:

Press side volume keys during a call in handset mode.

To adjust the headset volume via Phone interface:

Press side volume keys during a call in headset mode.

To adjust the speaker Volume via Phone interface:

Press side volume keys during a call in speaker mode.

Voice Mail Tone

This option can set whether to play the beep for phone's voice mail.

1. Login webpage, and click the Setting→ Preference
2. Select On or Off for Voice Mail Tone.
3. Click for the setting.

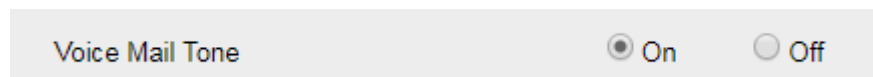

Play Hold Tone

When you hold the phone, whether to play hold tone.

1. Login webpage, and click the Setting→ Preference
2. Set On or Off for Play Hold Tone.
3. Click for the setting.

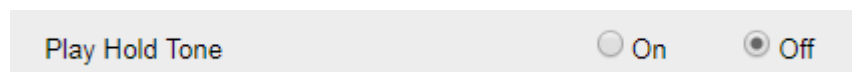

Play Hold Tone Delay

When you hold the phone, how many seconds to play beep?

1. Login webpage, and click the Setting→ Preference

2. Set the value for Play Hold Tone Delay.

3. Click for the setting.

Play Hold Tone Delay

Voice

Handfree AGC

AGC is the automatic gain control, which amplifies the sound according to the loudness of the speech during use. The most ideal effect when using AGC is that when the sound source is off, when the mic is closer or farther, the sound level on the opposite end is the same.

To configure Handfree AGC via Web interface:

1. Click Setting → Voice.

2. Enable the Handfree AGC field (Default).

3. Click to save the configuration.

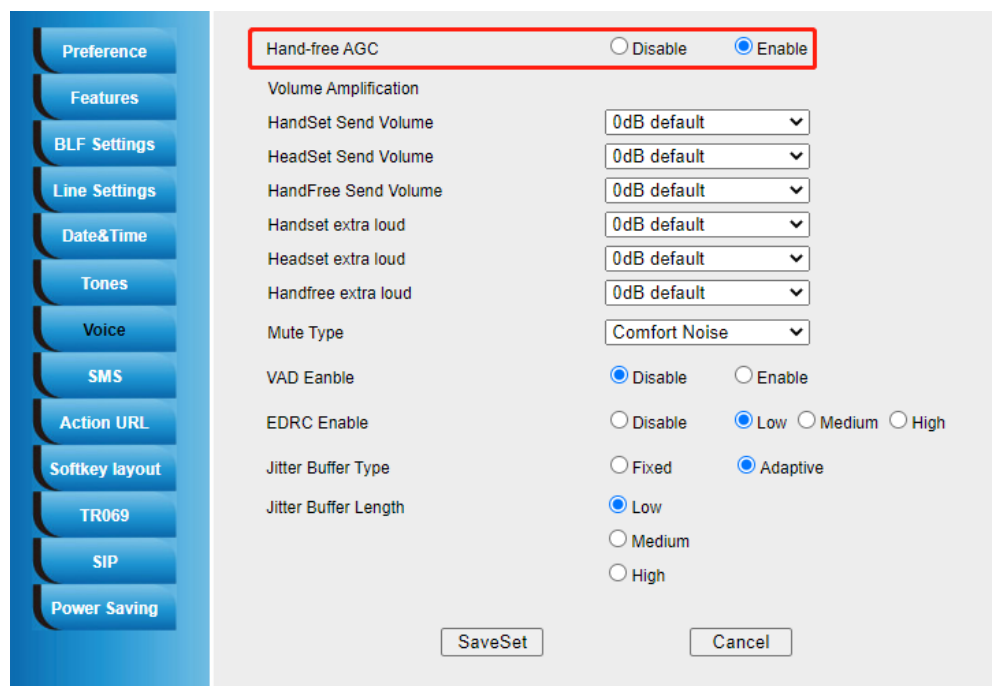

The screenshot shows the 'Voice' settings page. On the left is a navigation menu with options: Preference, Features, BLF Settings, Line Settings, Date&Time, Tones, Voice, SMS, Action URL, Softkey layout, TR069, SIP, and Power Saving. The 'Voice' option is selected. The main content area shows the 'Hand-free AGC' setting, which is currently set to 'Enable' (indicated by a red box around the radio button). Below this are several volume amplification settings, all set to '0dB default': HandSet Send Volume, HeadSet Send Volume, HandFree Send Volume, Handset extra loud, Headset extra loud, and Handfree extra loud. The 'Mute Type' is set to 'Comfort Noise'. At the bottom, there are 'SaveSet' and 'Cancel' buttons.

Volume Amplification

Handset Send Volume

A fixed gain that controls the volume sent by the Handset.

The AGC feature for handset is enabled by default. If you set this option, the AGC feature for handset will be closed.

To configure Handset Send Volume via Web interface:

1. Click Setting → Voice.
2. Select the desired value in the Handset Send Volume field.
3. Click to save the configuration.

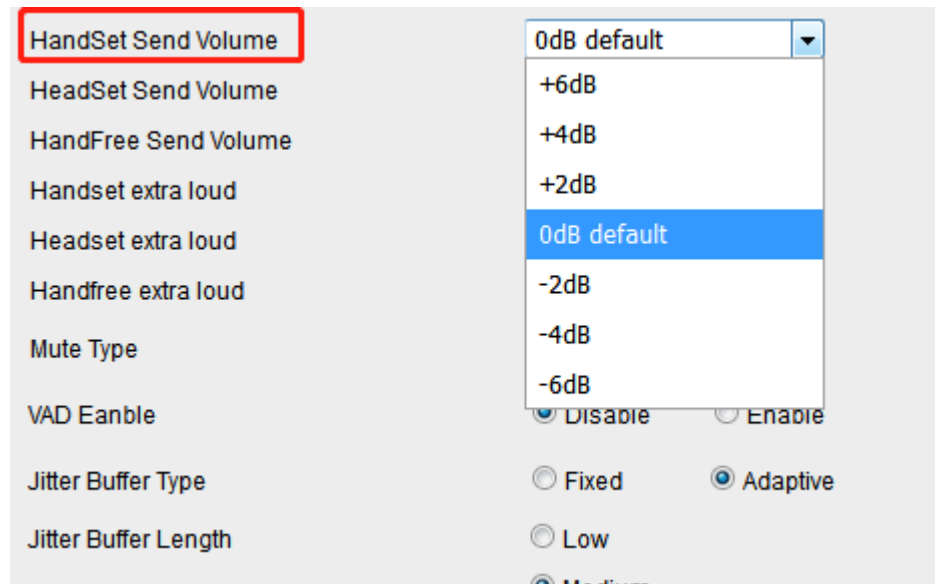

Headset Send Volume

A fixed gain that controls the volume sent by the Headset.

To configure Headset Send Volume via Web interface:

1. Click Setting → Voice.
2. Select the desired value in the Headset Send Volume field.
3. Click to save the configuration.

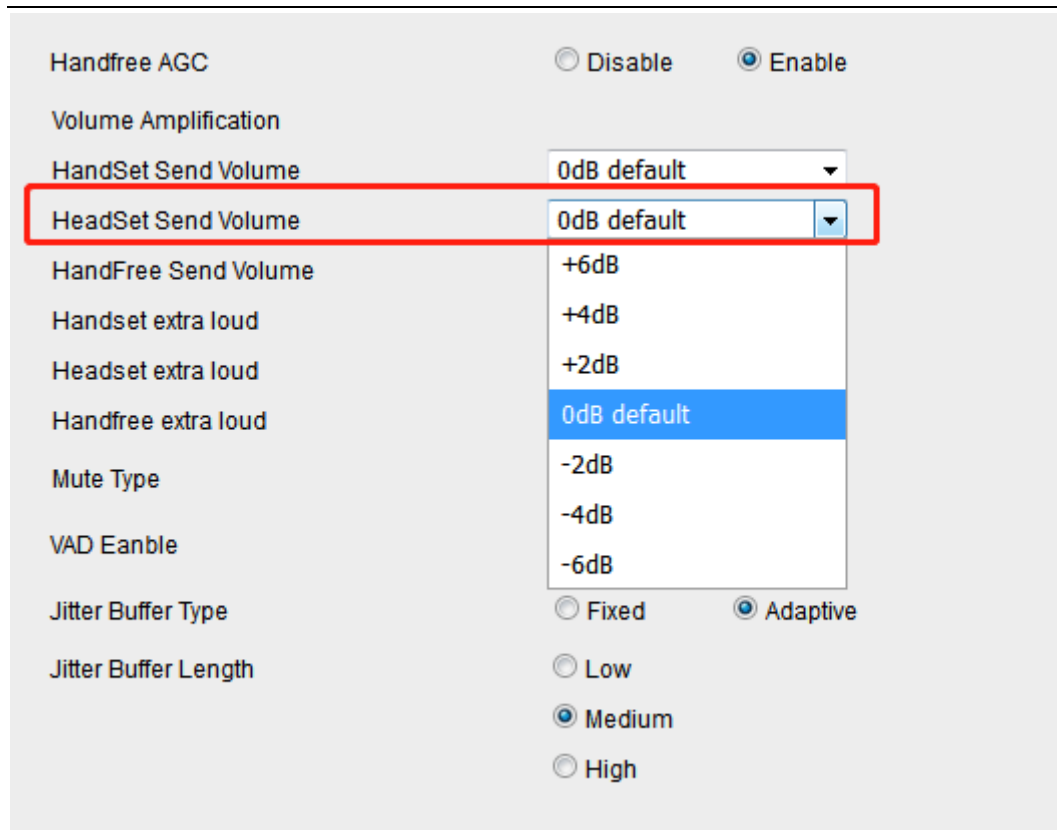

Handfree Send Volume

A fixed gain that controls the volume sent by the Handfree (speakerphone).
If Handfree AGC is enable, Handfree Send Volume option will not work.

To configure Handfree Send Volume via Web interface:

1. Click Setting → Voice.
2. Select the desired value in the Handfree Send Volume field.
3. Click to save the configuration.

Extra Loud

To configure Handset /Headset/Handfree extra loud via Web interface:

Handset /Headset/Handfree extra loud can control the size of the sound emitted from the speaker, and you can control an additional +2~+12 db.

1. Click Setting → Voice.
2. Select the desired value in the Handset /Headset/Handfree extra loud field.

3. Click to save the configuration.

Handfree AGC	<input type="radio"/> Disable <input checked="" type="radio"/> Enable
Volume Amplification	
HandSet Send Volume	0dB default
HeadSet Send Volume	0dB default
HandFree Send Volume	0dB default
Handset extra loud	0dB default
Headset extra loud	0dB default
Handfree extra loud	+2dB
Mute Type	+4dB
VAD Eanble	+6dB
Jitter Buffer Type	+8dB
Jitter Buffer Length	+10dB
	+12dB
	<input checked="" type="radio"/> Medium
	<input type="radio"/> High

Note:
 Only when the volume adjustment on the LCD is greater than +7, the extra loud will take effect.

Bluetooth

How to Activate Bluetooth?

To activate Bluetooth via Phone interface:

1. Find Menu then navigate as follows:
 Settings->Basic->Bluetooth:
2. Tap switch to save the configuration.

3. You will see the Bluetooth icon on phone's homepage status bar during the idle status. (This icon means that phone has no pair the Bluetooth device)

How to scan the Bluetooth headset device on phone interface:

1. Select "Pair New Device".
2. The phone will enter the scan interface, the phone starts searching for Bluetooth headsets within the working range of 10 meters (32 feet).
3. All detected Bluetooth headsets will display on the phone
4. Choose the desired Bluetooth Device from the list and connect to it:
5. If the Bluetooth Device is connected/paired successfully, you will see the "Connect Success!" and connected successfully icon.
6. If you want to disconnect with this Bluetooth device, you can press the "Enter" button, then press the "Disconnect" button.
7. When you back to idle interface, you will see the connected successfully icon

How to edit device information?

How to edit device information on phone interface:

1. Find Menu then navigate as follows:
Settings->Basic ->Bluetooth: Edit Device Information.

2. Tap the name of the desired device and you can edit the Device Name

Note:

The phone must be in the headphone mode to normally use the Bluetooth function.

How to answer an incoming call?

With the Bluetooth headset paired, press the multifunction key on the Bluetooth headset to answer an incoming call.

How to adjust the earphone volume during a call?

With the Bluetooth headset paired, you can do the following:

- Press the Volume key (+) on the phone to increase the volume. Press the Volume key (-) on the phone to decrease the volume.

How to End Call?

To end a call:

With the Bluetooth headset paired, press the multifunction key on the Bluetooth headset to end a call.

Wi-Fi

When the Wi-Fi feature is enabled, the IP phone will automatically scan the available wireless networks. All the available wireless networks will display in scanning list on the LCD screen. The Wi-Fi feature can be configured in two different ways: Manual and Provision.

Note: WIFI function will not connect when there is a network cable plugged in, you need to unplug the network cable to make the WIFI connect successfully.

How to Enable Wi-Fi feature?

Enabling Wi-Fi feature via Phone interface:



1. Tap Settings→Basic→ Wi-Fi or Menu  → Settings→ Basic→ Wi-Fi

You can also enable this function in the drop-down menu of the home interface

2. Tap the switch button  of **Use Wi-Fi** item.

How to Connect Smart Phone to an Available Wireless Network?

Connect to an available wireless network via Phone interface:

1. Tap Settings→Basic→ Wi-Fi or Menu  → Settings→ Basic→ Wi-Fi
2. Tap the switch button  of **Use Wi-Fi** item, you will see many available wireless networks:
3. Choose desired wireless network and then tap the item
4. You must enter the wireless network's password:
5. If the wireless network's password is correct, the wireless network will connect successfully



How to Disconnect Wireless Network?

Disconnect wireless network via Phone interface:

1. Enter Menu->Settings->Basic->Wi-Fi: The Storage Network
2. Select the current connected Wi-Fi.
3. Tap Disconnect .

How to Disable Wi-Fi feature?

To disable the Wi-Fi feature via Phone interface:

1. Tap Settings→Basic→ Wi-Fi or Menu  → Settings→ Basic→ Wi-Fi
2. Tap the switch button  of **Use Wi-Fi** item to turn off Wi-Fi feature.

Function Key

Line Keys

Line

To configure Line feature via phone interface

1. Tap Settings→ Features→ DSS Keys→ Line Key2(for example) or Menu  → Settings→ Features→ DSS Keys→ Line Key2(for example)
2. Tap **Type** to select the Line in the Type field.
3. Select the Account ID.
4. Tap **Save** to save the configuration.

Then the selected Line Key will work as Line.

To configure Line Feature via Web interface

1. Click Function Keys→ Line Key.
2. Select the wanted Line Key and set as Line.
3. Select the Account.
4. Click the button to save the configuration.

Line	Type	Mode	Value	Label	Account	Extension
Key1	Line	Default		025	Account 1	
Key2	BLF	Default	136		Account 1	
Key3	BLF	Default	137		Account 1	

Speed Dial

With this feature, you can dial one number by pressing the configured Speed Dial key.

To configure Speed Dial feature via Phone interface

1. Tap Settings→ Features→ DSS Keys→ Line Key2(for example) or Menu  → Settings→ Features→ DSS Keys→ Line Key2(for example)
2. Tap **Type** to select the Speed Dial in the Type field.
3. Enter the targeted Number in the Value field.
4. Select the Account ID.
5. Tap **Save** to save the configuration.

Then the selected Line Key will work as Speed Dial.

To configure Speed Dial feature via Web interface

1. Click Function Keys→ Line Key.
2. Select the wanted Line Key and set as Speed Dial.
3. Enter the desired phone number in the Value field.
4. Select the Account
5. Click the button to save the configuration.

Line	Type	Mode	Value	Label	Account	Extension
Key1	Line	Default		243	Account 1	
Key2	Speed Dial	Default	245		Account 1	

BLF

You can use the BLF (Busy Lamp Field) feature to monitor a specific extension number whether the extension is busy or free.

1. When the extension you are monitoring is idle, the BLF icon is steady green.
2. When the monitored extension is ringing, the BLF icon turns red, press the BLF icon to pick the IP Phone up directly.
3. When the monitored extension is calling or in a conversation, the BLF icon steady red.

To configure a BLF key via phone interface

1. Tap Settings→ Features→ DSS Keys→ Line Key2(for example) or Menu  → Settings→ Features→ DSS Keys→ Line Key2(for example).
2. Tap **Type** to select the BLF in the Type field.
3. Enter the targeted Number in the Value field.
4. Select the Account ID.
5. Enter the Pickup Code.
6. Tap **Save** to save the configuration.

To configure a BLF key via Web interface

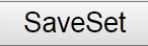
1. Click Function Keys→ Line Key.
2. Select the desired Line Key and select BLF in the Type field.
3. Enter the monitored phone number in the Value field.
4. Select the Account.
5. Fill in the Extension.
6. Click  to save the configuration.

Line	Type	Mode	Value	Label	Account	Extension
Key1	Line	Default		025	Account 1	
Key2	BLF	Default	136		Account 1	

DTMF

When the key is configured as DTMF key, you can send out the desired DTMF number during the conversation.

To use this feature, you should sure that the DTMF Tone is on.

To configure the DTMF Tone via Web interface

1. Click Setting→ Preference

2. Select On for Keypad DTMF Tone.
3. Click to save the configuration.

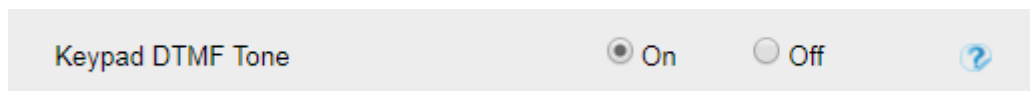

To configure the DTMF via Phone interface

1. Tap Settings→ Features→ DSS Keys→ Line Key2(for example) or Menu  → Settings→ Features→ DSS Keys→ Line Key2(for example)
2. Tap **Type** to select the DTMF in the Type field.
3. Enter the Value field with the desired DTMF number.
4. Tap **Save** to save the configuration.

To configure the DTMF via Web interface

1. Click Function Keys→ Line Key.
2. Select the desired Line Key and select DTMF in the Type field.
3. Fill in the Value field with the desired DTMF number.
4. Click the to save the configuration.

Line	Type	Mode	Value	Label	Account	Extension
Key1	Line	Default		243	Account 1	
Key2	DTMF	Default	0012		Account 1	

Prefix

If the key is configured as Prefix key, you can set the number prefix (e.g. Before the number plus 9), then you don't input 9, press the key and 9 will display on the LCD interface.

To configure the Prefix via Phone interface

1. Tap Settings→ Features→ DSS Keys→ Line Key2(for example) or Menu  → Settings→ Features→ DSS Keys→ Line Key2(for example)
2. Tap **Type** to select the Prefix in the Type field.
3. Enter the value field with number that you want to set as prefix.
4. Tap **save** to save the configuration.

To configure the Prefix via Web interface:

1. Click Function Keys→ Line Key.
2. Select the desired Line Key and select Prefix in the Type field.
3. Fill in the value field with number that you want to set as prefix.
4. Click to save the configuration.

Then when you press this key, the set value is input directly.

Line	Type	Mode	Value	Label	Account	Extension
Key1	Line	Default		243	Account 1	
Key2	Prefix	Default	9		Account 1	

Local Group

When use the Local Group feature, press the key and enter the Local Contacts interface quickly.

To configure the Local Group via Phone interface

1. Tap Settings→ Features→ DSS Keys→ Line Key2(for example) or Menu  → Settings→ Features→ DSS Keys→ Line Key2(for example)
2. Tap **Type** to select the Local Group in the Type field.
3. Tap **Save** to save the configuration.

To configure the Local Group via Web interface

1. Click Function Keys→ Line Key.
2. Select the desired Line Key and select Local Group in the Type field.
3. Click to save the configuration.

Then you can press the Local Group key to quickly enter the Local Contacts interface.

Line	Type	Mode	Value	Label	Account	Extension
Key1	Line	Default		243	Account 1	
Key2	Local Group	Default			Account 1	

XML Group

When use the XML Group feature, press the key and enter the Remote Contacts interface quickly.

To configure the XML group via Phone interface

1. Tap Settings→ Features→ DSS Keys→ Line Key2(for example) or Menu  → Settings→ Features→ DSS Keys→ Line Key2(for example)
2. Tap **Type** to select the XML Group in the Type field.
3. Select the Remote Phonebook.
4. Tap **Save** to save the configuration.

To configure the XML Group via Web interface

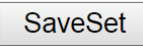
1. Click Function Keys→ Line Key.
2. Select the desired Line Key and select XML Group in the Type field.
3. Select the desired remote phonebook in the Account field.
4. Click  to save the configuration.

Line	Type	Mode	Value	Label	Account	Extension
Key1	Line ▼	Default ▼		243	Account 1 ▼	
Key2	XML Group ▼	Default ▼			remote pho ▼	

XML Browser

You can use this key to access the Xml browser quickly. The Xml browser allows you to create custom services which meet your functional requirements on the server. You can customize practical applications, such as weather report, stock information, Google search, etc.

To configure the XML Browser via Phone interface

1. Tap Settings→ Features→ DSS Keys→ Line Key2(for example) or Menu  → Settings→ Features→ DSS Keys→ Line Key2(for example)
2. Tap **Type** to select the XML Browser in the Type field.
3. Fill in the access URL for XML browser in the Value field.
4. Tap **Save** to save the configuration.

To configure the XML Browser via Web interface

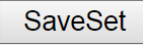
1. Click Function Keys→ Line Key.
2. Select the desired Line Key and select Xml Browser in the Type field.
3. Fill in the access URL for xml browser in the Value field. (e.g.: <http://10.2.0.140/XMLBrowser/TextMenu.xml>)
4. Click  button to save the configuration.

Line	Type	Mode	Value	Label	Account	Extension
Key1	Line	Default		243	Account 1	
Key2	XML Browser	Default	http://10.2.0		Account 1	

Network Directories

When using the BroadSoft Directory feature, by just pressing the key you can enter the Broadsoft Contacts interface its fast and convenient.

To configure the Network Directories via Phone interface

1. Tap Settings→ Features→ DSS Keys→ Line Key2(for example) or Menu → Settings→ Features→ DSS Keys→ Line Key2(for example)
2. Tap **Type** to select the BroadSoft Group in the Type field.
3. Select the Account ID.
4. Tap **Save** to save the configuration.

To configure the Network Directories via Web interface

1. Click Function Keys→ Line Key.
2. Select the desired Line Key and select Network Directories in the Type field.
3. Select the Account.
4. Click the button to save the configuration.

Line	Type	Mode	Value	Label	Account	Extension
Key1	Line	Default		243	Account 1	
Key2	Network Direct	Default			Account 1	

Then you can press the Network Directories key to quickly enter the Broadsoft Contacts interface.

To configure the Network Group via Web interface

1. Click Function Keys→ Line Key.
2. Select the desired Line Key and select Network Group in the Type field.
3. Select All
Contacts/Group/Interoperability/GroupCommon/EnterpriseCommon/Personal/Custom Directories for the Account.
4. Click the button to save the configuration.

Line	Type	Mode	Value	Label	Account	Extension
Key1	Line	Default		243	Account 1	
Key2	Network Group	Default			All Contact	

Then you can press the Network Group key to quickly enter the selected secondary directory of Broadsoft Contacts.

Conference

You can configure the line key to be used as a conference key.

To configure the Conference via Phone interface

1. Tap Settings → Features → DSS Keys → Line Key2(for example) or Menu  → Settings → Features → DSS Keys → Line Key2(for example)
2. Tap **Type** to select the Conference in the Type field.
3. Tap **Save** to save the configuration.

To configure Conference via Web interface

1. Click Function Keys → Line Key.
2. Select the desired Line Key and select Conference in the Type field.
3. Click the  button to save the configuration.

Line	Type	Mode	Value	Label	Account	Extension
Key1	Line	Default		243	Account 1	
Key2	Conference	Default			Account 1	

Forward

If the Forward Key has no configuration value, press it to enter the Always Forward configuration page.

If the forward key is configured with a value, please press this key to always turn it on, and this notification message will be displayed on the phone LCD. Press the forward key again to turn off this function. At this time, there is an incoming call, which can be dynamically forward.

To configure the Forward via Phone interface

1. Tap Settings→ Features→ DSS Keys→ Line Key2(for example) or Menu  → Settings→ Features→ DSS Keys→ Line Key2(for example)
2. Tap **Type** to select the Forward in the Type field.
3. Enter the Number to forward to in the Value field.
4. Tap **Save** to save the configuration.

To configure Forward via Web interface

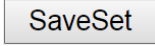
1. Click Function Keys→ Line Key.
2. Select the desired Line Key and select Forward in the Type field.
3. Enter the Value field with the number you want to forward to.
4. Click the  button to save the configuration.

Line	Type	Mode	Value	Label	Account	Extension
Key1	Line	Default		243	Account 1	
Key2	Forward	Default	245		Account 1	

Transfer

1. If the Transfer Key is configured with a value, then transfer will be executed directly, and it is related to [Transfer Mode via DSSKey](#).
2. If Transfer Key has no configuration value, it will be used as Transfer key.

To configure the Transfer via Phone interface

1. Tap Settings→ Features→ DSS Keys→ Line Key2(for example) or Menu  → Settings→ Features→ DSS Keys→ Line Key2(for example)
2. Tap **Type** to select the Transfer in the Type field.
3. Enter the Number to transfer to in the Value field.
4. Tap **Save** to save the configuration.

To configure Transfer via Web interface

1. Click Function Keys→ Line Key.
2. Select the desired Line Key and select Transfer in the Type field.
3. Enter the Value field with the number that wanted transfer to
4. Click the  button to save the configuration.

Line	Type	Mode	Value	Label	Account	Extension
Key1	Line	Default		243	Account 1	
Key2	Transfer	Default	245		Account 1	

Hold

The key can be configured as a hold key. You can use this key to hold and resume a call during the conversation.

To configure the Hold via Phone interface

1. Tap Settings→ Features→ DSS Keys→ Line Key2(for example) or Menu  → Settings→ Features→ DSS Keys→ Line Key2(for example)
2. Tap **Type** to select the Hold in the Type field.
3. Tap **Save** to save the configuration.

To configure the Hold via Web interface

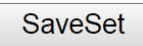
1. Click Function Keys→ Line Key.
2. Select the desired Line Key and select Hold in the Type field.
3. Click the  button to save the configuration.

Line	Type	Mode	Value	Label	Account	Extension
Key1	Line	Default		243	Account 1	
Key2	Hold	Default			Account 1	

DND

If the key is configured as DND key, allows you to activate the DND function immediately when you press it and the phone will reject all incoming calls automatically. Press it again to deactivate DND mode.

To configure the DND via Phone interface

1. Tap Settings→ Features→ DSS Keys→ Line Key2(for example) or Menu  → Settings→ Features→ DSS Keys→ Line Key2(for example)
2. Tap **Type** to select the DND in the Type field.
3. Tap **Save** to save the configuration.

To configure DND via Web interface

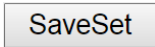
1. Click Function Keys→ Line Key.
2. Select the desired Line Key and select DND in the Type field.
3. Click the  button to save the configuration.

Line	Type	Mode	Value	Label	Account	Extension
Key1	Line ▼	Default ▼		243	Account 1 ▼	
Key2	DND ▼	Default ▼			Account 1 ▼	

To enable DND feature

Press the DND key when the phone is idle status, and then DND icon is shown on the LCD.

To disable DND feature

Press the DND key again, then there is no DND icon on the LCD.

Redial

If the key is configured as Redial key, you can redial the last dialed call from the IP Phone.

To configure Redial via Phone interface

1. Tap Settings→ Features→ DSS Keys→ Line Key2(for example) or Menu  → Settings→ Features→ DSS Keys→ Line Key2(for example)
2. Tap **Type** to select the Redial in the Type field.
3. Tap **Save** to save the configuration

To configure Redial via Web interface

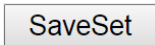
1. Click Function Keys→ Line Key
2. Select the desired Line Key and select Redial in the Type field.
3. Click the  button to save the configuration.

Line	Type	Mode	Value	Label	Account	Extension
Key1	Line ▼	Default ▼		243	Account 1 ▼	
Key2	Redial ▼	Default ▼			Account 1 ▼	

Record

With record feature, you can record your calls by pressing the record key.

To configure the Record via Phone interface

1. Tap Settings→ Features→ DSS Keys→ Line Key2(for example) or Menu  → Settings→ Features→ DSS Keys→ Line Key2(for example)
2. Tap **Type** to select the Record in the Type field.
3. Tap **Save** to save the configuration.

To configure the Record via Web interface

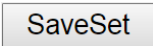
1. Click Function Keys→ Line Key.
2. Select the desired Line Key and select Record in the Type field.
3. Click the  button to save the configuration.

Line	Type	Mode	Value	Label	Account	Extension
Key1	Line ▼	Default ▼		243	Account 1 ▼	
Key2	Record ▼	Default ▼			Account 1 ▼	

Note:
Please contact the system administrator whether support this feature or not.

Group Listening

With this feature, when you have an active call, you can listen using Handset and speakerphone, but only can use the handset to speak.

To configure the Group Listening via Phone interface

1. Tap Settings→ Features→ DSS Keys→ Line Key2(for example) or Menu  → Settings→ Features→ DSS Keys→ Line Key2(for example)
2. Tap **Type** to select the Group Listening in the Type field.
3. Tap **Save** to save the configuration.

To configure the Group Listening via Web interface

1. Click Function Keys→ Line Key.

2. Select the desired Line Key and select Group Listening in the Type field.
3. Click to save the configuration.

Line	Type	Mode	Value	Label	Account	Extension
Key1	Line	Default		243	Account 1	
Key2	Group Listenin	Default			Account 1	

Public Hold

The key can be configured as a public hold key. During a conversation, all members belonging to that SLA group can use this key to hold and pick up with short press linekey on another extension.

To configure the Public Hold via Phone interface

1. Tap Settings→ Features→ DSS Keys→ Line Key2(for example) or Menu  → Settings→ Features→ DSS Keys→ Line Key2(for example)
2. Tap **Type** to select the Public Hold in the Type field.
3. Tap **Save** to save the configuration.

To configure the Public Hold via Web interface

1. Click Function Keys→ Line Key.
2. Select the desired Line Key and select Public Hold in the Type field.
3. Click the button to save the configuration.

Line	Type	Mode	Value	Label	Account	Extension
Key1	Line	Default		243	Account 1	
Key2	Public Hold	Default			Account 1	

Note:
Please contact the system administrator whether support this feature or not.

Private Hold

The key can be configured as a private hold key. During a conversation, all members belonging to that particular SLA group can use this key to hold the call, but only the initiator can resume the call with short press linekey.

To configure the Private Hold via Phone interface

1. Tap Settings→ Features→ DSS Keys→ Line Key2(for example) or Menu  → Settings→ Features→ DSS Keys→ Line Key2(for example)
2. Tap **Type** to select the Private Hold in the Type field.
3. Tap **Save** to save the configuration.

To configure the Private Hold via Web interface

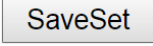
1. Click Function Keys→ Line Key.
2. Select the desired Line Key and select Private Hold in the Type field.
3. Click the  button to save the configuration.

Line	Type	Mode	Value	Label	Account	Extension
Key1	Line	Default		243	Account 1	
Key2	Private Hold	Default			Account 1	

Note:

Please contact the system administrator whether support this feature or not.

Multicast Paging

You can use multicast paging to forward out time sensitive announcements quickly and easily to people within the multicast group. You can configure a multicast paging key or a paging list key on the phone, which allows you to send a Real Time Transport Protocol (RTP) stream to the pre-configured multicast address/addresses without involving SIP signaling. You can configure the phone to receive an RTP stream from pre-configured multicast listening address/addresses without involving SIP signaling. You can specify up to 10 multicast listening addresses.

Sending RTP Stream

To configure a Multicast Paging key via Phone interface

1. Tap Settings→ Features→ DSS Keys→ Line Key2(for example) or Menu  → Settings→ Features→ DSS Keys→ Line Key2(for example).
2. Tap **Type** to select the Group Listening in the Type field.
3. Enter the multicast IP address and port number (e.g., 224.5.6.20:2000) in the Value field. The valid multicast IP addresses range from 224.0.0.0 to 239.255.255.255.
4. Tap **Save** to save the configuration.

To configure a Multicast Paging key via Web interface

1. Click Function Keys→ Line key:
2. Select the desired Line Key and select Multicast Paging in the Type field.
3. Enter the multicast IP address and port number (e.g., 224.5.6.20:2000) in the Value field. The valid multicast IP addresses range from 224.0.0.0 to 239.255.255.255.
4. Click the  button to save the configuration.

Line	Type	Mode	Value	Label	Account	Extension
Key1	Line	Default		243	Account 1	
Key2	MultiCast Pagi	Default	224.5.6.20:2		Account 1	

Sending RTP Stream:

Press the Multicast Paging key when the phone is idle.

The phone sends RTP to a preconfigured multicast address (IP: Port). Any phone in the local network then listens to the RTP on the preconfigured multicast address (IP: Port). For both sending and receiving of the multicast RTP, there is no SIP signaling involved. The Multicast Paging key LED will be solid green.

Receiving RTP Stream

You can configure the phone to receive a Real Time Transport Protocol (RTP) stream from the pre-configured multicast address/addresses without involving SIP signaling. You can specify up to 10 multicast addresses that the phone listens to on the network. How the phone handles incoming multicast paging calls depends on Paging Barge and Paging Priority Active parameters configured via web user interface.

Paging Barge

The paging barge parameter defines the priority of the voice call in progress. If the priority of an incoming multicast paging call is lower than that of the active call, it will be ignored automatically. If Disabled is selected from the pull-down list of Paging Barge, the voice call in progress will take precedence over all incoming multicast paging calls.

Valid values in the Paging Barge field:

- 1 to 10: Define the priority of the active call, 1 with the highest priority, 10 with the lowest.
- Disabled: The voice call in progress will take precedence over all incoming paging calls.

Paging Priority Active

The paging priority active parameter decides how the phone handles incoming multicast paging calls when there is already a multicast paging call on the phone. If enabled, the

phone will ignore incoming multicast paging calls with lower priorities, otherwise, the phone will answer incoming multicast paging calls automatically and place the previous multicast paging call on hold. If disabled, the phone will automatically ignore all incoming multicast paging calls.

Multicast Codec

You can only configure the codec via Web interface.

To configure Multicast Codec via Web interface

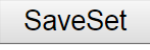
1. Click Directory→ Multicast Paging
2. Select the desired codec from the pull-down list of Multicast Codec
3. Click the  button to save the configuration.

Listening Address

To configure multicast listening addresses via Web interface:

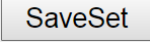
1. Click Directory→ Multicast Paging.
2. Select the desired value from the pull-down list of Paging Barge.
3. Select the desired value from the pull-down list of Paging Priority Active.
4. Enter the multicast IP address and port number (e.g., 224.5.6.20:2000) which the phone listens to for incoming RTP multicast in the Listening Address field.
5. Enter the label in the Label field.
6. Click  button to save the configuration.

Paging Barge

Paging Priority Active

Multicast Codec

Index	Listening Address	Label	Multi Priority
IP Address 1	<input type="text" value="224.5.6.20:2000"/>	<input type="text"/>	1
IP Address 2	<input type="text"/>	<input type="text"/>	2
IP Address 3	<input type="text"/>	<input type="text"/>	3
IP Address 4	<input type="text"/>	<input type="text"/>	4
IP Address 5	<input type="text"/>	<input type="text"/>	5
IP Address 6	<input type="text"/>	<input type="text"/>	6
IP Address 7	<input type="text"/>	<input type="text"/>	7
IP Address 8	<input type="text"/>	<input type="text"/>	8
IP Address 9	<input type="text"/>	<input type="text"/>	9
IP Address 10	<input type="text"/>	<input type="text"/>	10

Note:
 The priorities of listening to multicasting addresses can be predefined: 1 being the highest priority, 10 with the lowest in priority order. Both the multicast paging sender and receiver's phones play a warning tone when establishing a multicast paging call. Listening to Multicasting addresses can be configurable via Web interface only.

Customizing Your Phone

Administrator Password

The password is mainly used for login the web interface or set the advanced settings through phone interface. And the default password of the administrator is: **admin**.

To change to password via phone interface

1. Tap Settings→ Advanced setting→ Password (default: admin) → set Password or Menu  → Settings→ Advanced setting→ Password (default: admin) → set Password
2. Enter the Old Password, New Password and Ensure Password.
3. Tap Save to save the new password.

To change to password via Web interface

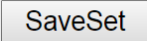
1. Management→ Password
2. Fill in the value (Maximum length of Current Password/New Password/Confirm Password)
3. Click  to save the configuration.

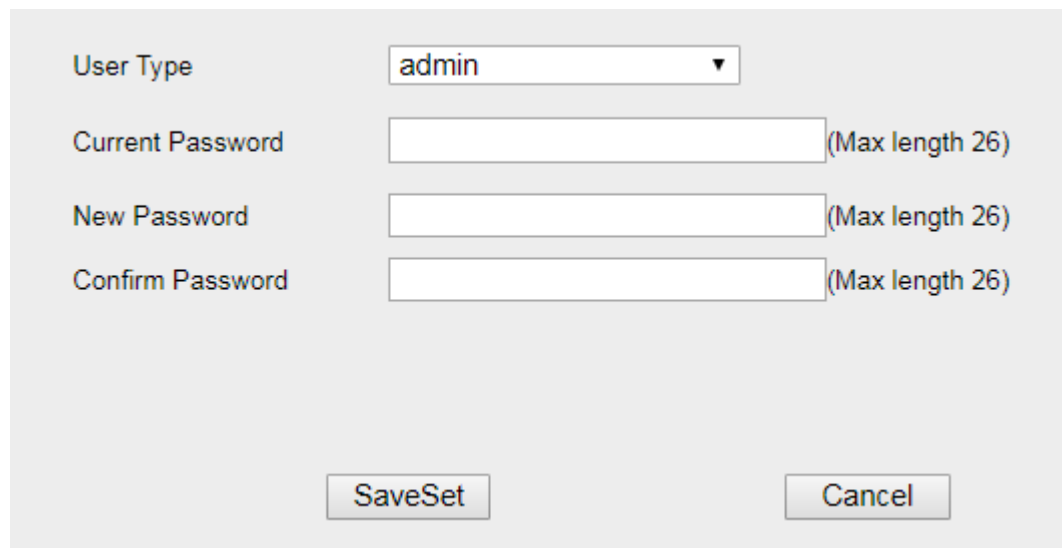

The screenshot shows a web interface for changing the administrator password. It features a dropdown menu for 'User Type' with 'admin' selected. Below are three text input fields for 'Current Password', 'New Password', and 'Confirm Password', each with a '(Max length 26)' label. At the bottom, there are two buttons: 'SaveSet' and 'Cancel'.

Note:
 When you use the web interface, default:
 username: admin
 password: admin

Language



The default Phone interface language is English.

To change the language via Phone interface

1. Tap Menu → Settings → Basic → Language & Input or Menu  → Settings → Basic → Language & Input .
2. Select the necessary one.
3. Tap **Save** to save the configuration.

To change the language via Web interface

1. Setting → Preference → Web Language & LCD Language
2. Select the necessary one.
3. Press  to save the configuration.

Web Language	English ▼	
LCD Language	English ▼	

Note:

All languages may not be available for selection. The available languages depend on the language packs currently loaded to the IP phone.

Wallpaper

To change wallpaper, go by the following steps:

To change the wallpaper via Phone interface:

1. Tap Settings → Basic → Display → Wallpaper or Menu  → Settings → Basic → Display → Wallpaper
2. Select the picture you want
3. Tap Set as wallpaper to save the selected picture as the wallpaper.

To change the wallpaper via Web interface:

1. Click Setting → Preference
2. Select the desired wallpaper picture to upload.

3. Click to save the setting.

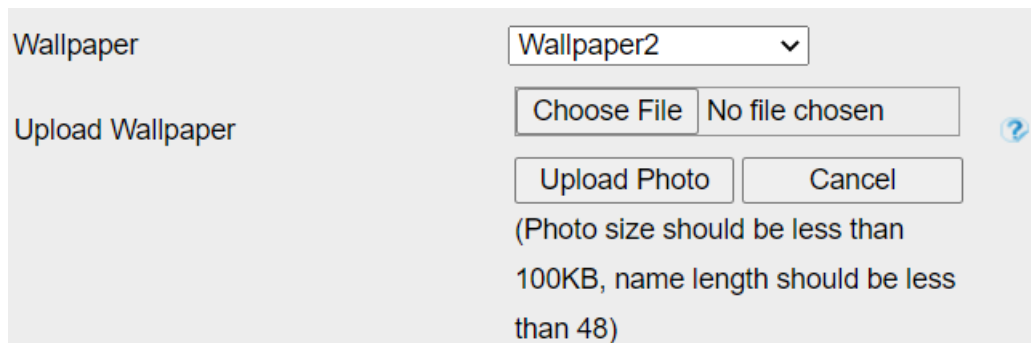

The screenshot shows a settings window for wallpaper. At the top, there is a dropdown menu labeled 'Wallpaper' with 'Wallpaper2' selected. Below it is a section for 'Upload Wallpaper' containing a 'Choose File' button, a 'No file chosen' status, and a help icon. At the bottom of this section are 'Upload Photo' and 'Cancel' buttons. A note below the buttons states: '(Photo size should be less than 100KB, name length should be less than 48)'.

Screen Saver

There are two types of screen saver: Clock and Colors.

Clock: When entering the screen saver, the screen will display the current time with a black background

Colors: When entering the screen saver, the screen will display a color picture

To enable screen saver via Phone interface:

1. Tap Settings→Basic→Display→ ScreenSaver or

Menu  →Settings→Basic→Display→ScreenSaver.

2. Select the type you want

3. Tap **Save** to save the selected configuration.

To disable screen saver via Phone interface

1. Tap Settings→Basic→Display→ ScreenSaver or

Menu  →Settings→Basic→Display→ScreenSaver.

2. Tap Switch to choose the Screensaver as off in Screensaver Waiting Time.

3. Tap Save to save the selected configuration.

Backlight

To set Backlight via Web interface:

1. Click Setting→ Preference

2. Enter the time for Backlight time (In seconds).
The default is 0, which means Backlight is always on.
3. Click to save the configuration.

Backlight Time 

Note:
Backlight Time refers to the time into the backlight.

Time and Date

Time and date is displayed on the idle page, and it can be set automatically by SNTP server or manually by manual setting.

To configure the time and Date by SNTP setting via Phone interface

1. Tap Settings→Basic→Time&Date→General or

Menu  →Settings→Basic→Time&Date→General

2. Tap Time Zone to change the Time zone.
3. Fill in the NTP Server1, NTP Server2.
4. Tap Save to save the configuration.

To configure time and date manually via Phone interface

1. Tap Settings→Basic→Time&Date→General or

Menu  →Settings→Basic→Time&Date→General

2. Tap **Type** to switch to **Manual Settings** mode
3. Change the right time, or you can input the right time.
4. Tap Save to save the configuration.

To configure the Time & Date Format via Phone interface

1. Tap Settings→Basic→Time&Date→Time And Date Format

or Menu  →Settings→Basic→Time&Date→Time And Date Format

2. Tap to change between 12 Hour or 24 Hour time display.
3. Tap to change date format.
4. Tap Save to save the configuration.

To configure the DHCP time via Phone interface

1. Tap Settings→Basic→Time&Date→DHCP time
2. Tap Switch to change between Disable and Enable.
3. Tap **Save** to save the configuration.

To configure the DHCP Option 100 via Web interface:

1. Log into the webpage (default username: admin, password: admin)
2. Setting→ Date & Time→ DHCP Option 100
3. Select Yes for the DHCP Option 100
4. Click to save the configuration.

DHCP Option 100	<input type="radio"/> No <input checked="" type="radio"/> Yes	?
-----------------	---------------------------------------------------------------	-------------------

To configure the NTP Server via Web interface

1. Log into the webpage (default username: admin, password: admin)
2. Setting→ Date & Time→ NTP Server
3. Fill in the value in the blank.
4. Click to save the configuration.

NTP Server	<input type="text" value="time.windows.com"/>	?
Backup NTP Server	<input type="text"/>	?

To change the Time Zone and Date Display Format via Web interface

1. Setting→ Date & Time
2. Select the necessary one.
3. Click to save the configuration.

DHCP Option 100	<input type="radio"/> No <input checked="" type="radio"/> Yes	?
DHCP Time	<input checked="" type="radio"/> No <input type="radio"/> Yes	?
Time Zone	<input type="text" value="-5 United States-Eastern Time"/>	?
NTP Server is Covered with DHCP	<input checked="" type="radio"/> No <input type="radio"/> Yes	?
NTP Server	<input type="text" value="time.windows.com"/>	?
Backup NTP Server	<input type="text"/>	?
Update Interval (15~86400s)	<input type="text" value="120"/>	?
Current Time	NTP Server DNS Resolve Failure	?
SIP Date Override Time	<input checked="" type="radio"/> No <input type="radio"/> Yes	?
Account(SIP Date Override Time)	<input type="text" value="Account 1"/>	?
Daylight Saving Time	<input checked="" type="radio"/> Disable <input type="radio"/> Enable <input type="radio"/> Auto	?
Time Format	<input checked="" type="radio"/> 24 Hour <input type="radio"/> 12 Hour	?
Date Display Format	<input type="radio"/> Year - Month - Day <input type="radio"/> Month - Day - Year <input checked="" type="radio"/> Day - Month - Year	?

To change the SIP Date Override Time via Web interface

1. Setting→ Date & Time→ SIP Date Override Time
2. Select Yes or No for SIP Date Override Time.
3. Click to save the configuration.

SIP Date Override Time No Yes ?

To change the Account via Web interface

1. Setting→ Date & Time→ Account.
2. Select Yes for SIP Date Override Time and select desired Account.
3. Click SaveSet to save the configuration.

DHCP Option 100	<input type="radio"/> No <input checked="" type="radio"/> Yes	?
DHCP Time	<input checked="" type="radio"/> No <input type="radio"/> Yes	?
Time Zone	<input type="text" value="-5 United States-Eastern Time"/>	?
NTP Server is Covered with DHCP	<input checked="" type="radio"/> No <input type="radio"/> Yes	?
NTP Server	<input type="text" value="time.windows.com"/>	?
Backup NTP Server	<input type="text"/>	?
Update Interval (15~86400s)	<input type="text" value="120"/>	?
Current Time	NTP Server DNS Resolve Failure	?
SIP Date Override Time	<input checked="" type="radio"/> No <input type="radio"/> Yes	?
Account(SIP Date Override Time)	<input type="text" value="Account 1"/>	?

To change the Daylight Saving Time via Web interface

1. Setting→ Date & Time→ Daylight Saving Time
2. Select Disable or Enable or Auto for Daylight Saving Time.
3. Click SaveSet to save the configuration.

Daylight Saving Time Disable Enable Auto ?

Note:
If the IP Phone cannot obtain the time and date from the Simple Network Time Protocol (SNTP) server, please contact your system administrator for more information.

Daylight Saving Time

Daylight Saving Time (DST) is the practice of temporary advancing clocks during the summertime so that evenings have more daylight and mornings have less. Typically, clocks are adjusted forward one hour at the start of spring and backward in autumn. Many countries have used the DST at various times, details vary by location. The DST can be adjusted automatically from the time zone configuration. Typically, there is no need to change this setting.

LED Status Setting

The LED Status setting mainly defines the power indicator LED.

To configure LED Status via Web interface:

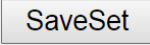
1. Click Setting → Preference
2. Select Yes or No for Power Status, Ringing Status, Miss Calls Status and Voice Message Status.
3. Click  for the setting.



For the LED status description, see LED Instruction [Power Indicator LED](#)

LED Status Setting:



Power Status	<input checked="" type="radio"/> Yes	<input type="radio"/> No
Ringing Status	<input checked="" type="radio"/> Yes	<input type="radio"/> No
MissCalls Status	<input type="radio"/> Yes	<input checked="" type="radio"/> No
Voice Message Status	<input type="radio"/> Yes	<input checked="" type="radio"/> No

Key as Send

To configure # as Send Key via Phone interface:

1. Tap Settings → Features → # Send or Menu  → Settings → Features → # Send
2. Tap the switch button  to **Enable**.
3. Tap **Save** to save the configuration.

To cancel # as Send key via Phone interface:

1. Tap Settings → Features → # Send or Menu  → Settings → Features → # Send
2. Tap the switch button  to **Disable**.
3. Tap **Save** to save the configuration.

To configure # as Send key via Web interface:

1. Click **Setting** → **Preference**.
2. Select Yes or No for **Use # As Dial Key**.
3. Click **SaveSet** for the setting.

Use # As Dial Key No Yes 

Dial Plan

Dial plan is a string of characters that governs the way this phone processes the inputs received from your phone keypad. This phone supports dial plan with following accepts digits:

1,2,3,4,5,6,7,8,9,0, *, #

Grammar	Description
x	any digit from 0-9;
xx+	at least 2-digit number;
^	exclude;
,	hear dial tone;
[3-5]	any digit of 3, 4, or 5;
[147]	any digit 1, 4, or 7;
<2=011>	replace digit 2 with 011 when dialing.

To configure dial plan via Web interface:

1. Click Account→ Basic.
2. Select the desired account from the pull-down list of Account in the Account field.
3. Fill in the value in Dial Plan field (Maximum length 1024).
4. Click to save the configuration.

Account	Account 1
Account Status	025@10.13.0.12:5060 : Registered; UDP
* Account Active	<input type="radio"/> No <input checked="" type="radio"/> Yes
Profile	Profile 1
Label	<input type="text"/> ?
* SIP User ID	025 ?
* Authenticate ID	025 ?
* Authenticate Password	●●●●●●●● ?
Name	<input type="text"/> ?
Local SIP Port	5060 ?
Use Random Port	<input checked="" type="radio"/> No <input type="radio"/> Yes
Voice Mail UserID	<input type="text"/> ?
Dial Plan	{[x*]+}
Eventlist BLF URL	<input type="text"/>
Shared Line	Disable
SCA Barge-In	Disable ?
Direct Call Pickup Code	<input type="text"/>
Group Call Pickup Code	<input type="text"/>
Feature Key Sync	Disable

Note:

1. Illegal input will fall back to default: {[x*]+}, illegal characters refer to all characters not within {}.
2. If the number you entered does not match the dial plan, you will not be able to make outgoing calls.

Phone Lock

To enable Keypad Lock via Phone interface:

1. Tap Settings→ Advanced Setting→ Phone Settings→ Phone Lock or Tap

Menu  →Settings→ Advanced Setting→ Phone Settings→ Phone Lock

2. Change Lock to All Keys,set Unlock Pin,Auto Lock,Timeout and Emergency Call (if need)

3. Press Save button to save the configuration.

To disable Keypad Lock via Phone interface:

1.Tap Settings→ Advanced Setting→ Phone Settings→ Phone Lock or Tap

Menu  →Settings→ Advanced Setting→ Phone Settings→ Phone Lock

2. Change Lock to Disable.

3. Press Save button to save the configuration.

To enable Keypad Lock via Web interface:

1. Click Setting→ Features→ Phone Lock

2. To choose All Keys, Menu Key, or Function Keys for the Keypad Lock.

3. Fill in the Phone Unlock Pin and Auto Lock Time-Out.

4. Fill in the Emergency number. When the phone is Lock, only Emergency number can be sent.

5. Click  to save the configuration.

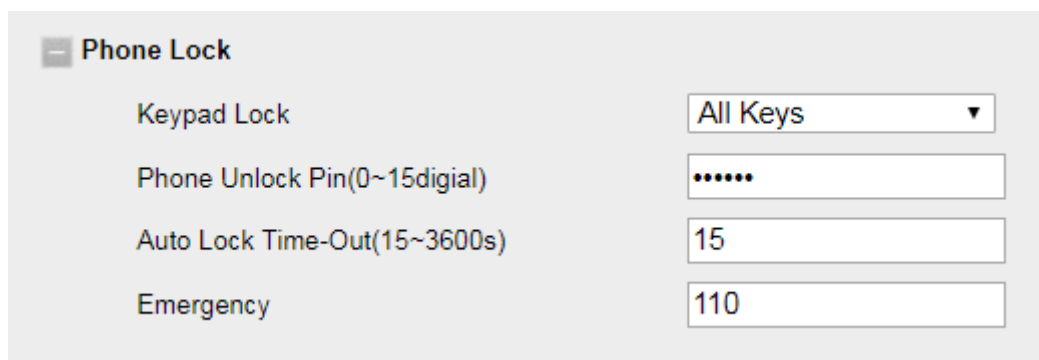

The screenshot shows the 'Phone Lock' settings screen. It has a title bar with a minus sign and the text 'Phone Lock'. Below the title bar, there are four rows of settings, each with a label on the left and a control on the right:

- Keypad Lock:** A dropdown menu currently showing 'All Keys'.
- Phone Unlock Pin(0~15dial):** A text input field containing six dots.
- Auto Lock Time-Out(15~3600s):** A text input field containing the number '15'.
- Emergency:** A text input field containing the number '110'.

To Disable Keypad Lock via Web interface:

1. Click Setting→ Features→ Phone Lock

2. Choose Disable for the Keypad Lock.

3. Click  to save the configuration.

Emergency Call

Public telephone networks in countries around the world have a single emergency telephone number (emergency services number), that allows a caller to contact local emergency services for assistance when required. The emergency telephone number may differ from country to country. It is typically a three-digit number that can be easily remembered and dialed quickly. Some countries have a different emergency number for each of the different emergency services.

You can specify the emergency telephone numbers on the Desk Phone for contacting the emergency services in an emergency.

To configure emergency call via Web interface:

1. Click Setting→ Features→ Phone Lock
2. Enter the emergency services number in the Emergency field (maximum length 63).
3. Click to save the configuration.

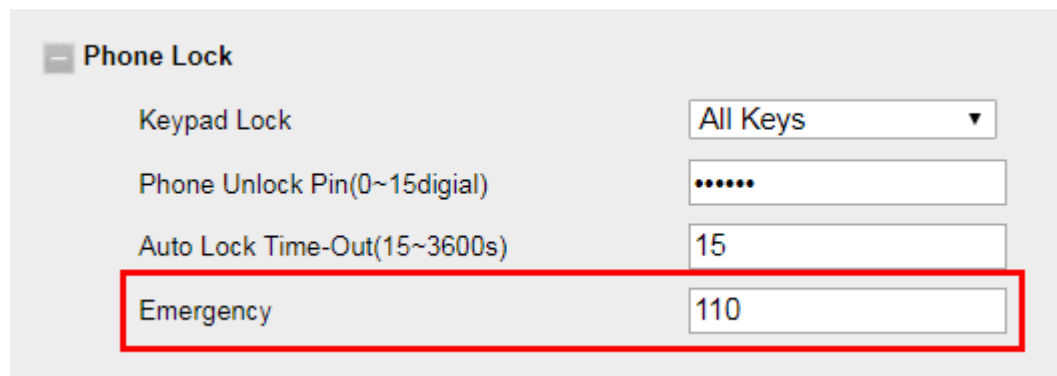

The screenshot shows the 'Phone Lock' configuration page. It includes the following fields:

- Keypad Lock: All Keys (dropdown menu)
- Phone Unlock Pin(0~15digital): (password field)
- Auto Lock Time-Out(15~3600s): 15 (text input)
- Emergency: 110 (text input, highlighted with a red box)

Note: If multiple emergency calls are configured, they can be separated by commas. For example: 110,119,120.

Action URL

To configure action URL via Web interface:

1. Click Setting→ Action URL
2. Fill in the needed values in the designated blank spaces.
3. Click to save the configuration.

Setup Completed	<input type="text"/>	?
Log On	<input type="text"/>	?
Log Off	<input type="text"/>	?
Register Failed	<input type="text"/>	?
Off Hook	<input type="text"/>	?
On Hook	<input type="text"/>	?
Incoming Call	<input type="text"/>	?
Outgoing Call	<input type="text"/>	?
Call Established	<input type="text"/>	?
Call Terminated	<input type="text"/>	?
Open DND	<input type="text"/>	?
Close DND	<input type="text"/>	?
Open Always Forward	<input type="text"/>	?
Close Always Forward	<input type="text"/>	?

Open Busy Forward	<input type="text"/>	?
Close Busy Forward	<input type="text"/>	?
Open No Busy Forward	<input type="text"/>	?
Close No Busy Forward	<input type="text"/>	?
Transfer Call	<input type="text"/>	?
Blind Transfer call	<input type="text"/>	?
Attended Transfer Call	<input type="text"/>	?
Hold	<input type="text"/>	?
Unhold	<input type="text"/>	?
Mute	<input type="text"/>	?
Unmute	<input type="text"/>	?
Missed Call	<input type="text"/>	?
Idle To Busy	<input type="text"/>	?
Busy To Idle	<input type="text"/>	?
Forward Incoming Call	<input type="text"/>	?
Reject Incoming Call	<input type="text"/>	?
Answer New Incoming Call	<input type="text"/>	?
Transfer Finished	<input type="text"/>	?
Transfer Failed	<input type="text"/>	?

Settings

General Settings

Dial-Now Timeout

Dial-Now Timeout means that when you enter the number which is matching with dial plan, it will dial out automatically after some time when you stop entering the number.

To configure Dial-Now Timeout via Web interface:

1. Click Setting→ Preference
2. Fill the blank of Dial-Now Timeout: for example, 5(seconds).
0 means dial out immediately, default is 0 seconds, max is 29 seconds (between 0 to 29).
3. Click the button to save the configuration.

Dial-now Time-out (seconds)	<input type="text" value="5"/>	
-----------------------------	--------------------------------	-------------------------------------------------------------------------------------

No Key Entry Timeout

No Key Entry Timeout means that when you enter the number, it will dial out automatically after some time when you stop enter the number.

To configure No Key Entry Timeout via Web interface:

1. Click Setting→ Preference
2. Fill the blank of No Key Entry Timeout: for example, 5(seconds).
In seconds,0 means will not timeout, you should press the Dial key to dial out the number, default is 0 seconds, max is 29 seconds (between 0 to 29).
3. Click the button to save the configuration.

NO Key Entry Timeout(seconds)	<input type="text" value="5"/>	
-------------------------------	--------------------------------	---------------------------------------------------------------------------------------

Show Missed Calls

Whether to show missed call notification on LCD.

After turning off this function, all missed calls will not be displayed. If there are missed calls after turning it on again, the total number of missed calls during turning off and after turning on again will be displayed.

Note:

1. If it is turned on again, the missed call count during the closed period will not be displayed immediately but will be displayed together after the missed call count is increased again.
2. The data before closing Miss call will be cleared.

To configure Show Missed Calls via Web interface:

1. Click Setting→ Preference
2. Select Yes or No for Show Missed Calls.

3. Click for the setting.

Show Missed Calls	<input checked="" type="radio"/> Yes	<input type="radio"/> No	
-------------------	--------------------------------------	--------------------------	-------------------------------------------------------------------------------------

Auto Logout Time

Set the Web login timeout.

1. Login webpage, and click Setting→ Preference
2. Set number 1~5000 min for Auto Logout Time.
3. Click for the setting.

Auto Logout Time (1 ~ 5000 min)	<input type="text" value="6"/>
---------------------------------	--------------------------------

Reboot in Talking

This function is to allow reboot during the calls or not. When this function is disabled, reboot will not be executed immediately during the call, but will be executed after the call ends. When this function is enabled, reboot will be executed immediately during the call.

1. Login webpage, and click Setting→ Preference
2. Set Enable or Disable for Reboot in Talking.
3. Click for the setting.

Reboot in Talking	<input type="text" value="Disable"/>
-------------------	--------------------------------------

Redial Mode

Call redial has two ways:

- (1) To redial the last placed call from the IP Phone.
- (2) To redial the call from all calls list.

1. Login webpage, and click Setting→ Preference
2. Set Direct Mode or Select Mode for Redial Mode.
3. Click for the setting.

Redial Mode	<input checked="" type="radio"/> Direct Mode	<input type="radio"/> Select Mode
-------------	----------------------------------------------	-----------------------------------

Suppress DTMF Display

Whether to hide DTMF during the call; if this function is enabled, the DTMF during the call will be displayed as *.

1. Login webpage, and click Setting→ Preference
2. Select On or Off for Suppress DTMF Display.
3. Click for the setting.

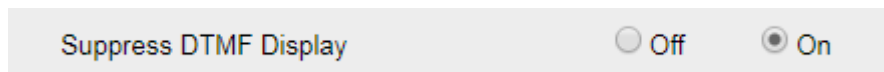

Headset Mode

How to configure Headset Priority via Phone interface:

1. Find Menu then navigate as follows: Menu->Settings->Basic ->Headset:
2. Enable the Headset Priority.
3. Choose the “Use Headset” or “Speaker&Headset” from “Ringer Device” option.
4. Press the save button to save the configuration.

To configure Headset Priority via web interface:

1. Login the phone’s webpage (Username: admin, Password: admin)
2. Setting->Preference. Enable the Headset priority. Choose the “Use HeadSet” or “Speaker&Headset” from “Ringer Device” option.

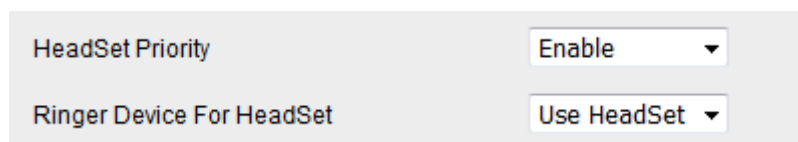

3. Click the button to save the configuration.

To enable the headset mode:

Enable headset mode when headset priority is enabled:

1. Press the headset key on phone’s during the idle status when you accomplish the above-mentioned configuration.
2. Headset icon will display on phone status bar.

Enable headset mode when headset priority is not enabled:

- Tap the headset key on phone

After pressing the headset key, the phone enters the dialing mode. And the headset is used only for calling.

When dialing or calling, the headset is used as an answer mode, and the headset is not used by default as in the preceding case.

Network setting

IP Phone currently only supported IPv4. They have two mode of Network: DHCP and Static. The default mode is DHCP, it will obtain IP address and other information automatically.

If your phone cannot contact a DHCP server for any reason, you need to configure a static IP address manually.

When switch DHCP and Static IP Address, or change the Static IP on webpage, it will show the warning of restart as following.

Network settings have been changed, Are you sure reboot the phone to save changes?

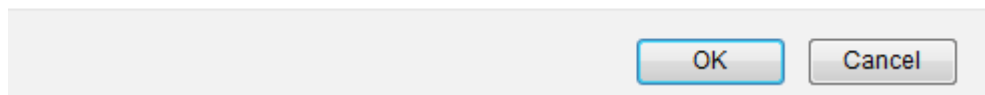

IPv4

If you set IP Mode to IPv4, IP phone will use IPv4 address. IPv4 has two network modes: DHCP and Static.

To configure IPv4 via Phone interface:

1. Tap Settings→Advanced(password: admin)→Network or

Menu  →Settings→Advanced(password: admin)→Network→ WAN Port→ IP Port Mode

2. Change the IP Port Mode.
3. Tap **Save** to save the configuration.

To configure IPv4 via Web interface:

1. Click Network→ Basic→ Internet Port
2. Select IPv4 for Internet Port.

3. Click  for the setting.

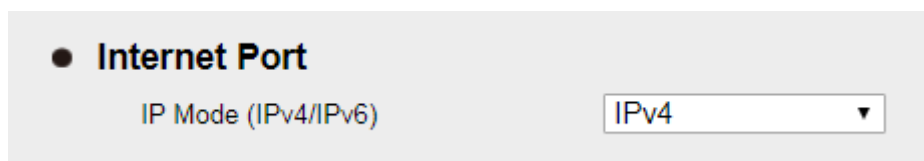

To configure DHCP via Phone interface:

1. Tap Settings→Advanced(password: admin)→Network→ WAN Port→ IP Port Mode→IPv4→ DHCP mode

or Menu  →Settings→Advanced(password: admin)→Network→ WAN Port→ IP Port Mode→IPv4→ DHCP mode.

2. Click Save and the pop-up box shows "System will reboot, Are you sure?".

To configure a static IP address via Phone interface:

1. Tap Settings→Advanced(password: admin)→Network→ WAN Port→ IP Port Mode→IPv4→ static mode

or Menu  →Settings→Advanced(password: admin)→Network→ WAN Port→ IP Port Mode→IPv4→ static mode.

2. Enter the parameters: IP, Netmask, Gateway, Pri.DNS (primary DNS), Sec.DNS (second DNS) in the corresponding fields.

3. Click Save and the pop-up box shows "System will reboot, Are you sure?".

4. Tap OK to accept the change or the Cancel button to cancel.

To configure Network via Web interface:

1. Click Network→ Basic→ IPv4 Setting

2. Select the desired Type: DHCP or Static IP Address.

3. Fill in the necessary information.

4. Click  and the pop-up box shows "System will reboot, Are you sure?".

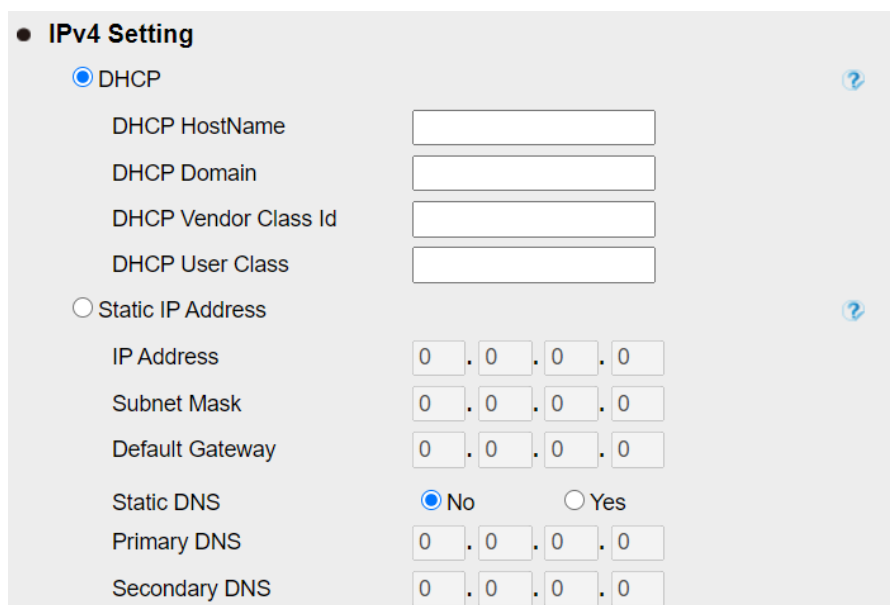

IPv4 Setting

DHCP 

DHCP HostName

DHCP Domain

DHCP Vendor Class Id

DHCP User Class

Static IP Address 

IP Address

Subnet Mask

Default Gateway

Static DNS No Yes

Primary DNS

Secondary DNS

PC Port

Two modes for PC Port: bridge and Connect to Expansion Module.

To Select the PC Port via Phone interface:

1. Tap Settings→Advanced(password: admin)→Network→ PC Port→ Bridge /Router/Connect to Module.

or Menu  →Settings→Advanced(password: admin)→Network→ PC Port→ Bridge /Router/Connect to Module.

2. Click Save and the pop-up box shows "System will reboot, Are you sure?".
3. Click the OK, then the phone will reboot.

To Select the PC Port via Web interface:

1. Click Network→ PC Port

2. Select As Bridge/Connect to Expansion Module.

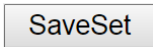
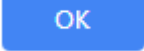
3. Click  and then click , the phone will reboot automatically.

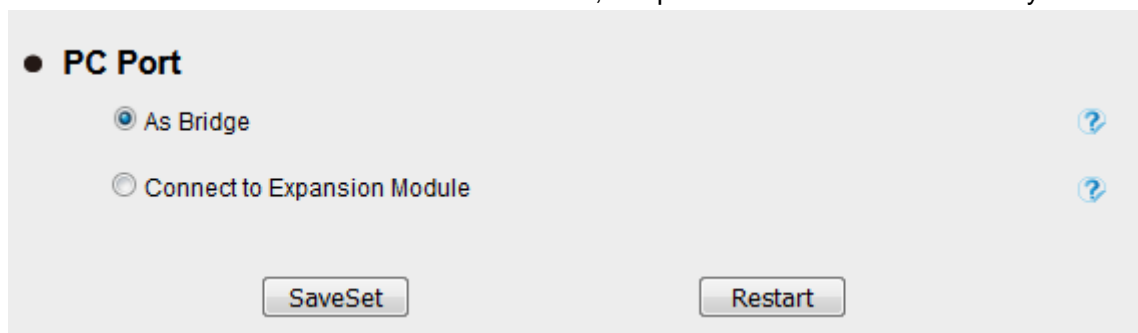

Note: The As Bridge mode is selected by default, and the “Connect to Expansion Module” mode is only required when the phone is connected to the expansion module.

System setting

Factory Reset

To set Factory Reset via Phone interface

1. Press Menu→ Settings→ Advanced Setting (default password: **admin**)→ Phone Setting→ Factory Reset

2. Press OK button in the warning page.

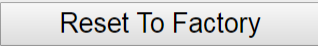

To set Factory Reset via Web interface

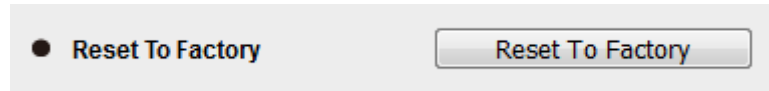
1. Click Management→ Upgrade
2. Click  and then confirm the setting.



Pcap Feature

To use Pcap feature via Web interface:

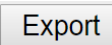
1. Click Management→ Tools
2. Click  and then operation the phone
3. When finishing the operation, click  and then click .
4. Then you'll get the Pcap captures.

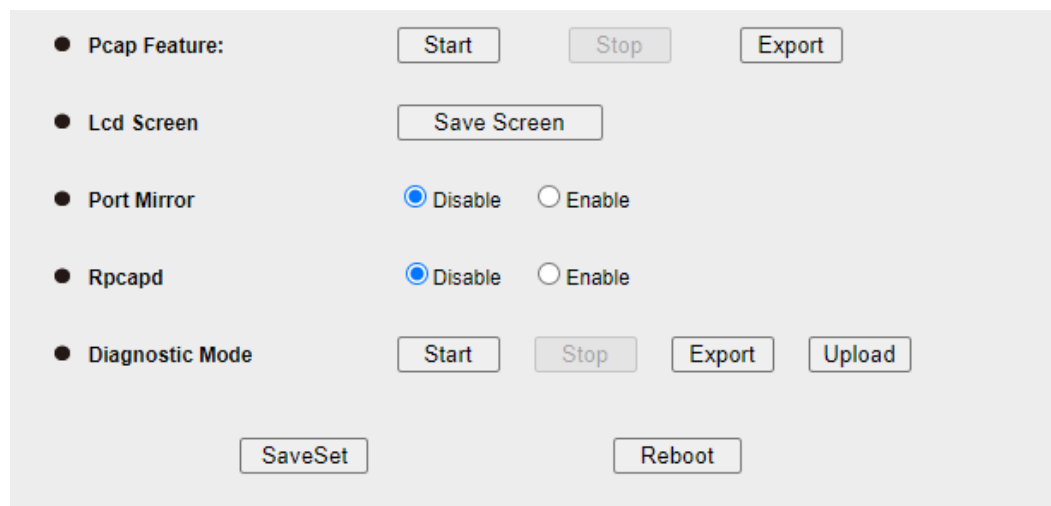

System Log

To download system log via Web interface:

1. Click Management→ Configuration
2. Select the Syslog Level

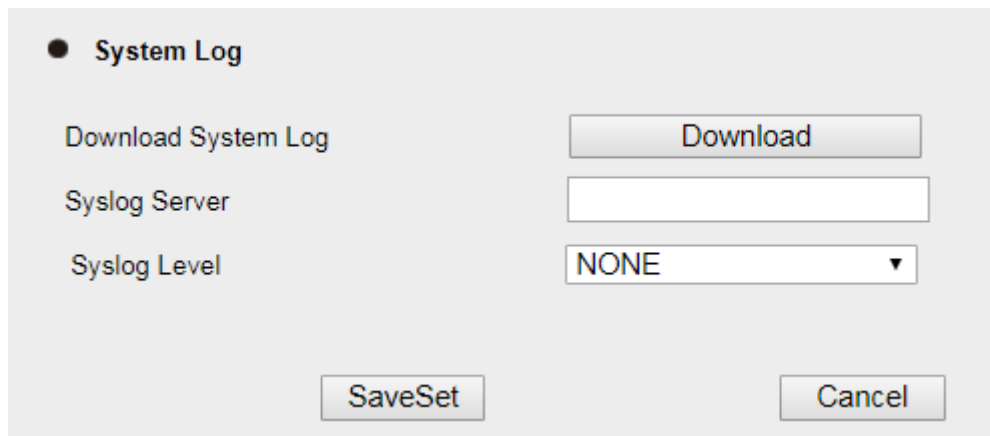

3. Click  of the System Log.
4. Then you will get a txt file: syslog.txt.

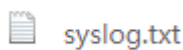

Upgrade

To upgrade via HTTP, the “Management” → “Auto Provision” → “Firmware Upgrade” → “Upgrade Mode” field needs to be set to HTTP, respectively. “Firmware Server Path” needs to be set to a valid URL of a HTTP server, server name can be in either FQDN or IP address format. Here are examples of some valid URL.

e.g. firmware.mycompany.com:5688

e.g. www.mycompany.com:5688/fm

e.g. 218.2.83.110

Instructions for firmware upgrade via HTTP:

- (1) End users can choose to download the free HTTP server from <http://httpd.apache.org/> or use Microsoft IIS web server. Then setup HTTP server.
- (2) Unzip the firmware file and put all of them under the *root/fm* directory of the HTTP server.
- (3) Visit “http://192.168.0.254/fm/” on localhost by browser to verify the HTTP Server. If visiting “http://192.168.0.254/fm/” on another computer and it is not prompted to download fw920D.rom file on this computer, please check if the firewall is on or off (Suggest you turn off the firewall).

To configure the server path via Web interface:

1. Click Management→ Auto Provision
2. Select the upgrade mode in the Upgrade Mode field
3. Enter the Firmware Server Path and Config Server Path (192.168.0.254 is HTTP server).
4. Enter the HTTP server’s username and password (optional).
5. Click the  button to save the configuration.

6. Restart the Smart Phone, IP Phone will restart and auto-get firmware files from HTTP server.

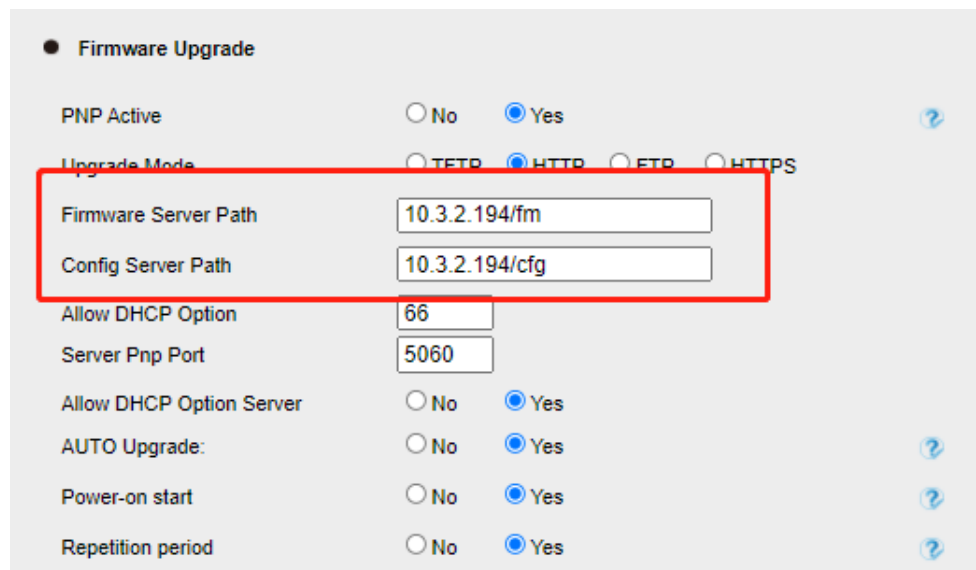

Firmware Upgrade

PNP Active No Yes

Upgrade Mode TFTP HTTP FTP HTTPS

Firmware Server Path

Config Server Path

Allow DHCP Option

Server Pnp Port

Allow DHCP Option Server No Yes

AUTO Upgrade: No Yes

Power-on start No Yes

Repetition period No Yes

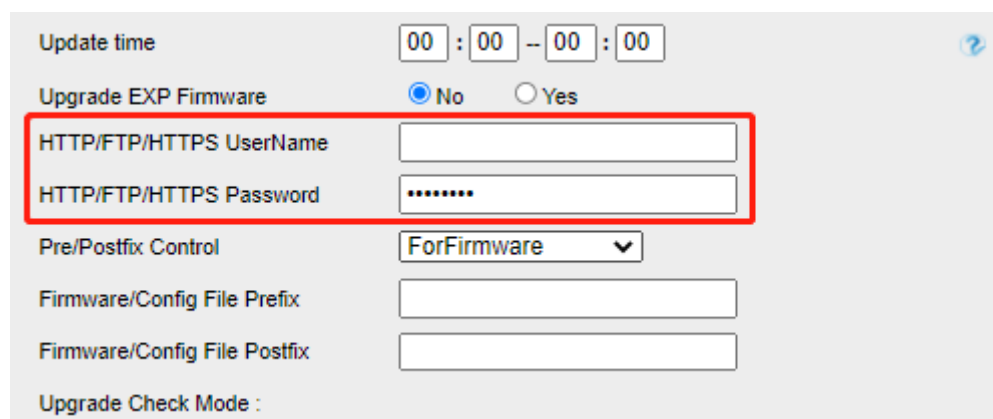

Update time : - :

Upgrade EXP Firmware No Yes

HTTP/FTP/HTTPS UserName

HTTP/FTP/HTTPS Password

Pre/Postfix Control

Firmware/Config File Prefix

Firmware/Config File Postfix

Upgrade Check Mode :

To upgrade manually via the Web configuration interface

1. Click Management→ Upgrade
2. Click or the blank.
3. Select the firmware and then click .

Configuration File

To download configuration file

1. Click Management→ Configuration→ Configure File
2. Click the or , then you can get a file: cfg.xml or cfg.bin.

● **Configure File**

Download Device Xml Configuration	Download Xml File
Restore Xml Configuration	Choose File No file chosen
	Restore Xml Configuration
Download Device Bin Configuration	Download Bin File
Restore Bin Configuration	Choose File No file chosen
	Restore Bin Configuration
Download User Bin Configuration	Download User Bin File
Delete User Configuration	Delete User File

To restore a configuration file

1. Click Management→ Configuration→ Configure File

2. Select the xxx.xml or xxx.bin file, and then Click the

or , then IP Phone will reboot.

● **Configure File**

Download Device Xml Configuration	Download Xml File
Restore Xml Configuration	Choose File No file chosen
	Restore Xml Configuration
Download Device Bin Configuration	Download Bin File
Restore Bin Configuration	Choose File No file chosen
	Restore Bin Configuration
Download User Bin Configuration	Download User Bin File
Delete User Configuration	Delete User File

Optional Accessories with Your Phone

Headsets

The phone supports wired headset and Bluetooth headset to place and answer calls. You can use only one headset at a time.



Bluetooth Headset

You can use a Bluetooth headset to handle calls on the phones. For more information, refer to the documentation from your Bluetooth headset manufacturer.

Using Headsets

After connecting a headset to your phone, you can activate the headset mode and use the headset when answering and placing calls. If you do not want to use a headset to handle calls, you can deactivate the headset mode.

To use the headsets:

1. Tap  on the phone.
2. The headset icon appears on the phone screen.
3. Tap  again on the phone.

The headset icon disappears from the phone screen.